

2023
DRYWALL
SOLUTIONS
CATALOG

54



Jacksonville, FL



SUPERIOR SOLUTIONS

Trim-Tex is the manufacturer of the world's strongest and most versatile line of corner beads, all produced in the USA. Made from a proprietary blend of at least 70% recycled vinyl materials, Trim-Tex corner beads are the most durable in their class; will never rust; and have standardized, efficient install processes that cut down on material costs. Since 1969, we have been creating paint-ready interior finishing solutions alongside contractors, architects and engineers that save you time, money and headaches on the job.

Our award-winning customer service team is available to answer your questions and assist in getting you the product you need. With same-day shipping and hundreds of products always in stock, we can help you prevent jobsite delays.

Whether you need one box or a truckload, Trim-Tex has you covered.

0690° Soft Profile

1090° Sharp Profile

14..... **New!** Fast Edge Rolls

16..... Bullnose

22..... Influencer Spotlight: Refresh Home Improvements

24..... Chamfer

28..... Reveal & Shadow Beads

32..... J Beads

36..... L Beads

40 What Is Buttboard?

42..... Made for Movement

46..... Code Compliance

50 Sound Gasket Case Study: Chula Vista, CA

52..... Acoustical & Ceiling Beads

56..... Returns & Jambs

60 Tools & Accessories

66..... Technical Specifications

70..... Index



Escanee aquí para
descargar una copia del
catálogo en español



90° Corner Bead
 (pg. 08)



Inside Corner Bead
 (pg. 13)



Bullnose Bead
 (pg. 18)



Chamfer Bead
 (pg. 26)



Reveal Bead
 (pg. 30)



F Reveal Bead
 (pg. 30)



Z Shadow Bead
 (pg. 30)



J Bead
 (pg. 34)



L Bead
 (pg. 38)



Tear Away™ L Bead
 (pg. 38)



Flat Tear Away™ L Bead
 (pg. 38)



093V Expansion
 (pg. 44)



Hideaway Expansion
 (pg. 44)



Deflection Bead
 (pg. 44)

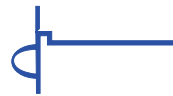

Super Seal
 Tear Away™ L Bead
 (pg. 45)



Fire & Sound Gasket
 (pg. 49)



Hotrod XL™
 (pg. 48)



Flex Grid Angle
 (pg. 55)



Mud On Ceiling Bead
 (pg. 55)



Fast Cap
 (pg. 58)

SOFT PROFILE

These Soft Profile corner beads – featuring a tasteful, slightly rounded corner and simple glue-and-staple installation method – are Trim-Tex’s bread and butter, giving drywall pros a smooth finish that will look pristine for years to come.



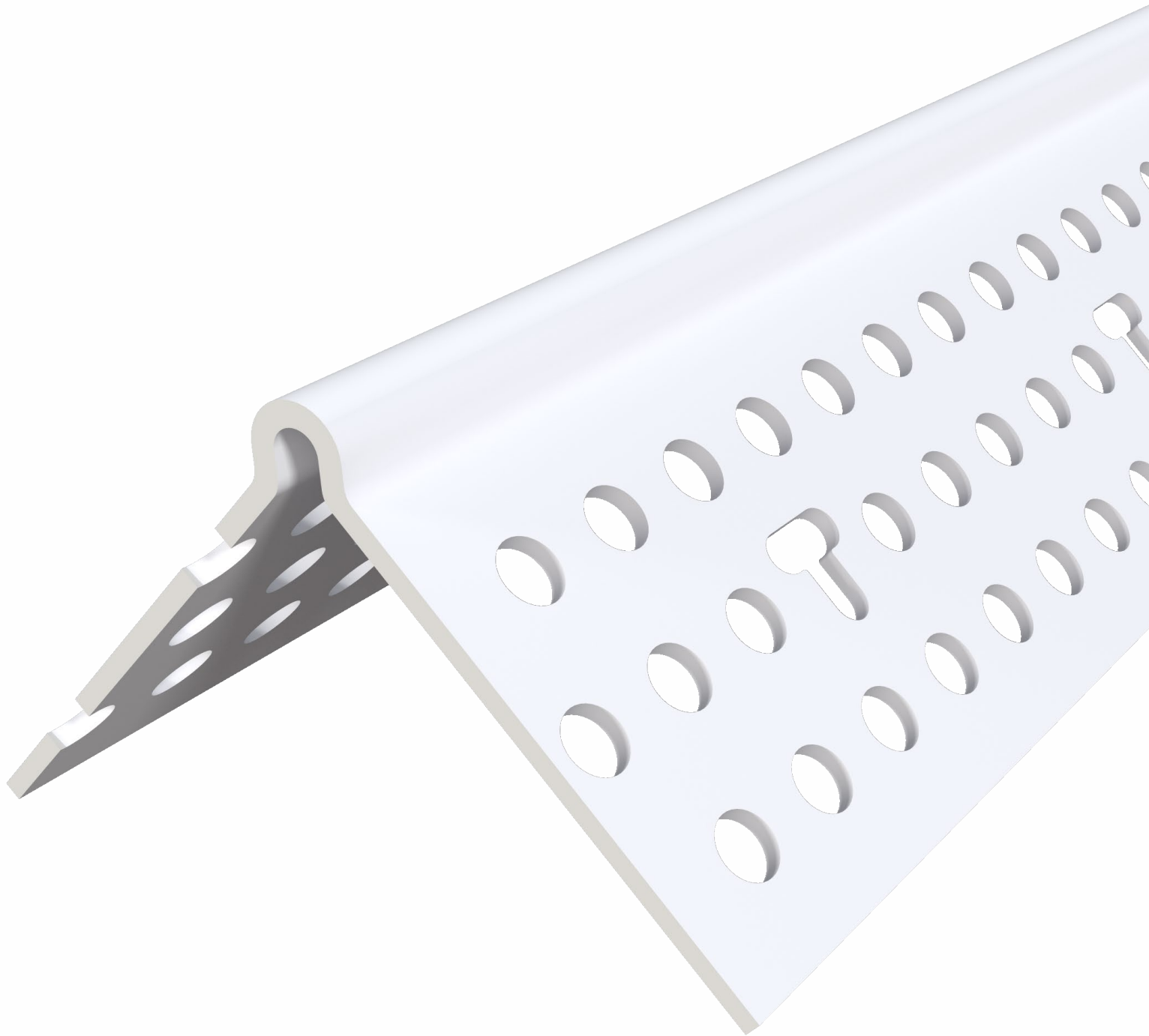

Corner Bead and Archway

Why use vinyl corner beads? They're more durable, more flexible and more sustainable (each Trim-Tex bead is made from at least 70% recycled materials) than their steel counterparts – and that's just the tip of the iceberg. Trim-Tex's standard Corner Bead & Archway is our touchstone for finishing 90-degree corners, while the bendable archway variety is the perfect choice for curved surfaces.

| STOCK NO. | LENGTH | PCS. PER BOX |
|----------------|--------|--------------|
| 400609 | 6' 9" | 50 |
| 4008 | 8' | 50 |
| 4009 | 9' | 50 |
| 4010 | 10' | 50 |
| 4012 | 12' | 50 |
| ARCHWAY | | |
| 4110 | 10' | 50 |

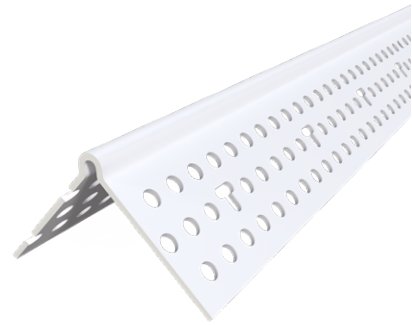

Jumbo Corner Bead and Archway

Jumbo Corner Bead & Archway is a supersized tweak on our classic corner bead design, featuring a slight radius on its nose. The bead helps to prevent cracking on lofts, balconies and all bridging, with extra-wide 1 3/4" mud legs. With this single solution, you're able to finish up to two full layers of 5/8" drywall.

| STOCK NO. | LENGTH | PCS. PER BOX |
|----------------|--------|--------------|
| J008 | 8' | 40 |
| J009 | 9' | 40 |
| J010 | 10' | 40 |
| ARCHWAY | | |
| JA10 | 10' | 40 |



Outside Splayed Corner Bead

Drywall finishers need to be prepared for more than just your average 90-degree corners, which makes a box or two of Splayed Corner Bead a downright necessary part of your inventory. This solution suits a range of splayed outside corner angles, from 120 degrees to 140 degrees.

| STOCK NO. | LENGTH | PCS. PER BOX |
|-----------|--------|--------------|
| 4210 | 10' | 70 |



Jumbo Splayed Corner

The strength, ease of use and durability of Jumbo Corner Bead is now available for splayed outside corners, with extra-wide 1 3/4" mud legs. The bead is formed for a true 135-degree splayed outside corner, but can be adjusted in the field without any tools to fit other splayed outside angles, from 120 degrees to 140 degrees.

| STOCK NO. | LENGTH | PCS. PER BOX |
|-----------|--------|--------------|
| JS10 | 10' | 40 |

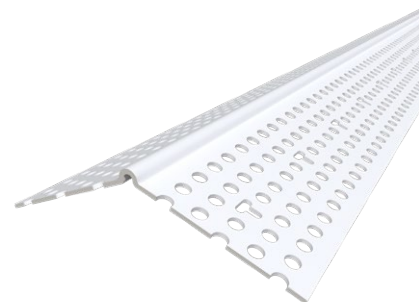

THESE CORNER BEADS WERE HIT WITH **THE SAME FORCE.**

METAL:
Irreparable
Damage

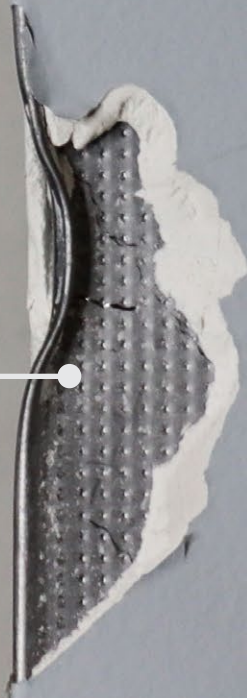

VINYL:
5-Minute
Mud Patch

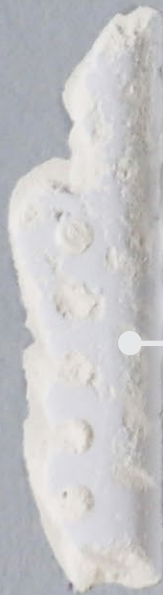

**ENOUGH
SAID.**

TRIM-TEX[®]
DRYWALL SOLUTIONS

SHARP PROFILE

For a sharper angle that's easy on the eyes, our selection of Sharp Profile beads provide flawlessly crisp corners, with a variety of installation methods to choose from: classic glue-and-staples application, Mud Set for unmatched durability and Fast Edge® for finishing in a flash.

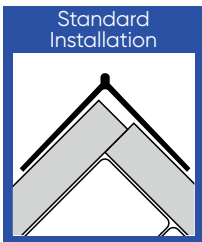

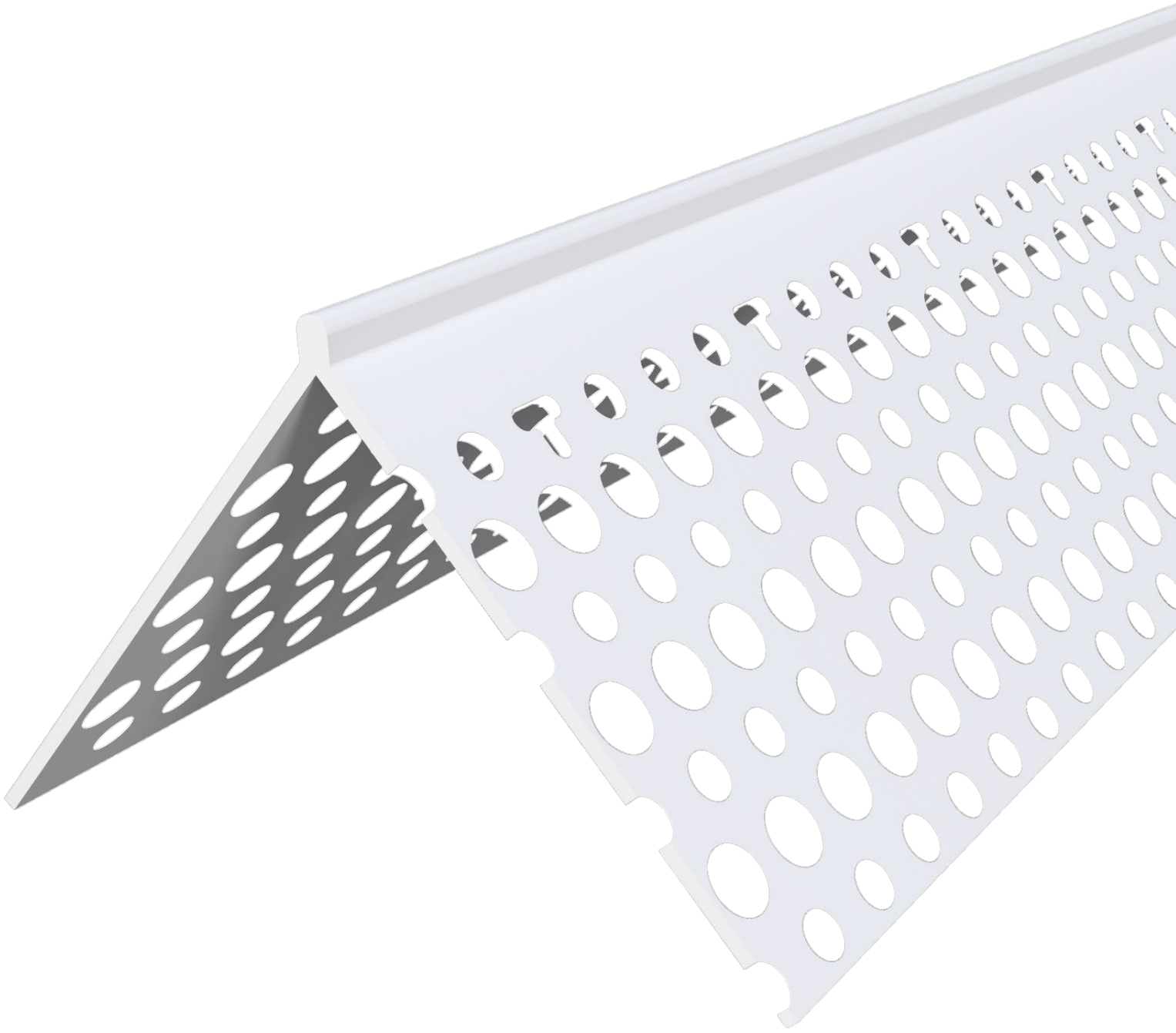

Rigid Low Profile Corner Bead and Archway

The Rigid Low Profile Corner Bead & Archway is a variation on our standard 90-degree vinyl corner bead that requires less mud and no setback to finish. With its sharp rigid nose, this is a great choice for a level-five finish. Available with an 81-degree closed angle (CA) for use with bad framing.

| STOCK NO. | LENGTH | PCS. PER BOX |
|----------------|--------|--------------|
| R010LP | 10' | 45 |
| R008CA | 8' | 45 |
| R009CA | 9' | 45 |
| R010CA | 10' | 45 |
| ARCHWAY | | |
| RA10LP | 10' | 45 |



Mud Set Rigid Low Profile Corner Bead

Mud Set Beads are the strongest and most impact-resistant corner solutions on the market, and the Mud Set Rigid Low Profile Corner Bead is a great go-to choice for heavy-duty 90-degree corners, with no setback required. This extra-resilient solution also saves you 25% on labor by allowing the fill coat to be applied the same day as installation.

| STOCK NO. | LENGTH | PCS. PER BOX |
|-----------|--------|--------------|
| MSR008LP | 8' | 50 |
| MSR009LP | 9' | 50 |
| MSR010LP | 10' | 50 |



Rigid Jumbo Low Profile Corner Bead and Archway

The Rigid Jumbo Low Profile Corner Bead & Archway comes equipped with extra-wide mud legs, and requires less mud and no setback to finish. With its sharp rigid nose, this is a great choice for a level-five finish in schools, hospitals, office buildings and more. Will finish up to two layers of 5/8" drywall.

| STOCK NO. | LENGTH | PCS. PER BOX |
|----------------|--------|--------------|
| RJ10LP | 10' | 45 |
| RJ10CA | 10' | 45 |
| ARCHWAY | | |
| RJA10LP | 10' | 45 |

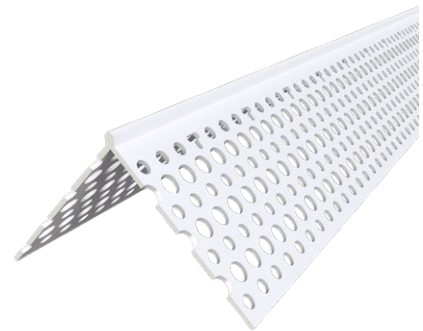

Mud Set Rigid Jumbo Low Profile Corner Bead

Mud Set Beads are the strongest and most impact-resistant corner solutions on the market, and this Jumbo version of our Mud Set Rigid Low Profile Corner Bead comes with extra-wide 1 3/4" mud legs for heavy-duty 90-degree corners. Ideal for a level-five finish, with no setback required, this solution easily finishes two layers of 5/8" drywall.

| STOCK NO. | LENGTH | PCS. PER BOX |
|-----------|--------|--------------|
| MSRJ10LP | 10' | 50 |



Rigid Splayed Adjustable Corner Bead

The Rigid Splayed Adjustable Corner Bead is a variation on our standard splayed vinyl corner bead that requires less mud and no setback to finish. With a sharp rigid nose, its hinged design allows the bead to adjust to finish an outside corner from 115 to 155 degrees.

| STOCK NO. | LENGTH | PCS. PER BOX |
|-----------|--------|--------------|
| RS10 | 10' | 40 |

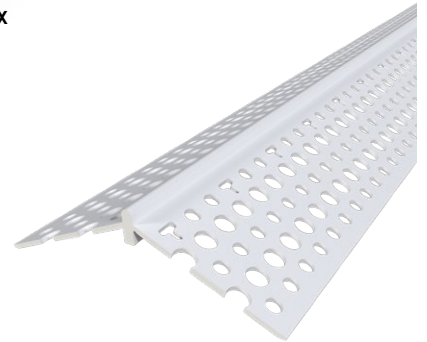

Adjustable Inside Corner Bead

Your inside corners deserve a little more love than just taping them – our Adjustable Inside Corner Bead is designed to create inside corners that are more impact-resistant, straighter and sharper than paper tape for crisp paint lines. Its design allows the bead to adjust to finish an inside corner from 70 to 150 degrees.

| STOCK NO. | LENGTH | PCS. PER BOX |
|-----------|--------|--------------|
| 4310 | 10' | 70 |



Fast Edge[®]

Fast Edge features a sharp nose with no mud bump, and tapered legs to significantly reduce mud usage and drastically speed up installation. With no holes, Fast Edge cuts down installation and finishing time significantly, and the patented mud locks keep the corner held firmly in place without the need for staples or adhesives.

| STOCK NO. | LENGTH | PCS. PER BOX |
|-----------|--------|--------------|
| FE08 | 8' | 50 |
| FE10 | 10' | 50 |

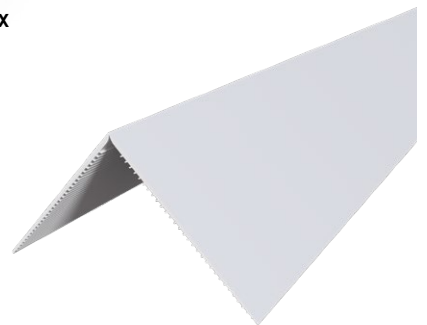

Fast Edge[®] Paper

Fast Edge Paper could be the most advanced 90-degree corner bead Trim-Tex has ever made. Made of laminated paper over a vinyl core, the bead's patented mud locks keep the corner held firmly in place without the need for staples or adhesives. Fast Edge Paper gives you a quicker finish – while using the least amount of joint compound – over any other solution on the market.

| STOCK NO. | LENGTH | PCS. PER BOX |
|-----------|--------|--------------|
| FEP08 | 8' | 50 |
| FEP09 | 9' | 50 |
| FEP10 | 10' | 50 |
| FEP12 | 12' | 50 |



New!

FAST EDGE® ROLLS

Roll with the best! Fast Edge – the next generation of corner bead, known far and wide for having the quickest installation on the market while using the least amount of mud – is now available in a convenient, highly flexible rolled form in four widths: 2.75", 3.25", 3.75" and 4.50". Tackle off-angle inside and outside corners faster than ever, while our patented mud locks featured on the bead's paper-covered vinyl core provide unmatched bond strength and durability.

| STOCK NO. | WIDTH | LENGTH |
|-----------|-------|--------|
| FE275R | 2.75" | 100' |
| FE325R | 3.25" | 100' |
| FE375R | 3.75" | 100' |
| FE450R | 4.50" | 100' |



“THIS IS MY NEW GO-TO.”

"I've used Trim-Tex beads for years. When Fast Edge Paper came out, that was it – I knew that these were going to be the only beads I'd ever use. I just knew right away, this is a game-changer. Using Fast Edge Roll along with Fast Edge Paper – it's a great combination!"

- Phil Ciufo, PRC Taping

 @prctaping



BULLNOSE

Bullnose corner beads, with their soft, rounded profiles, create striking and unmistakable details, and can spice up your interior design with a sprinkling of Southwestern flavor.

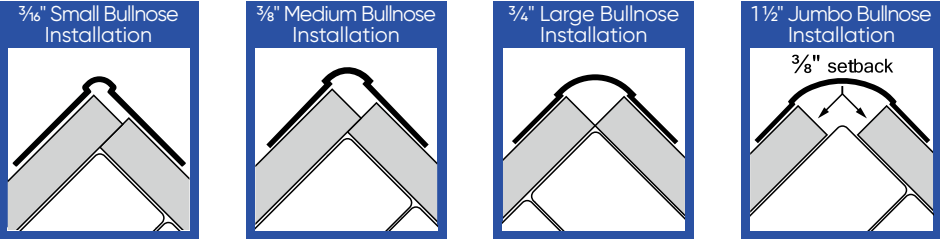

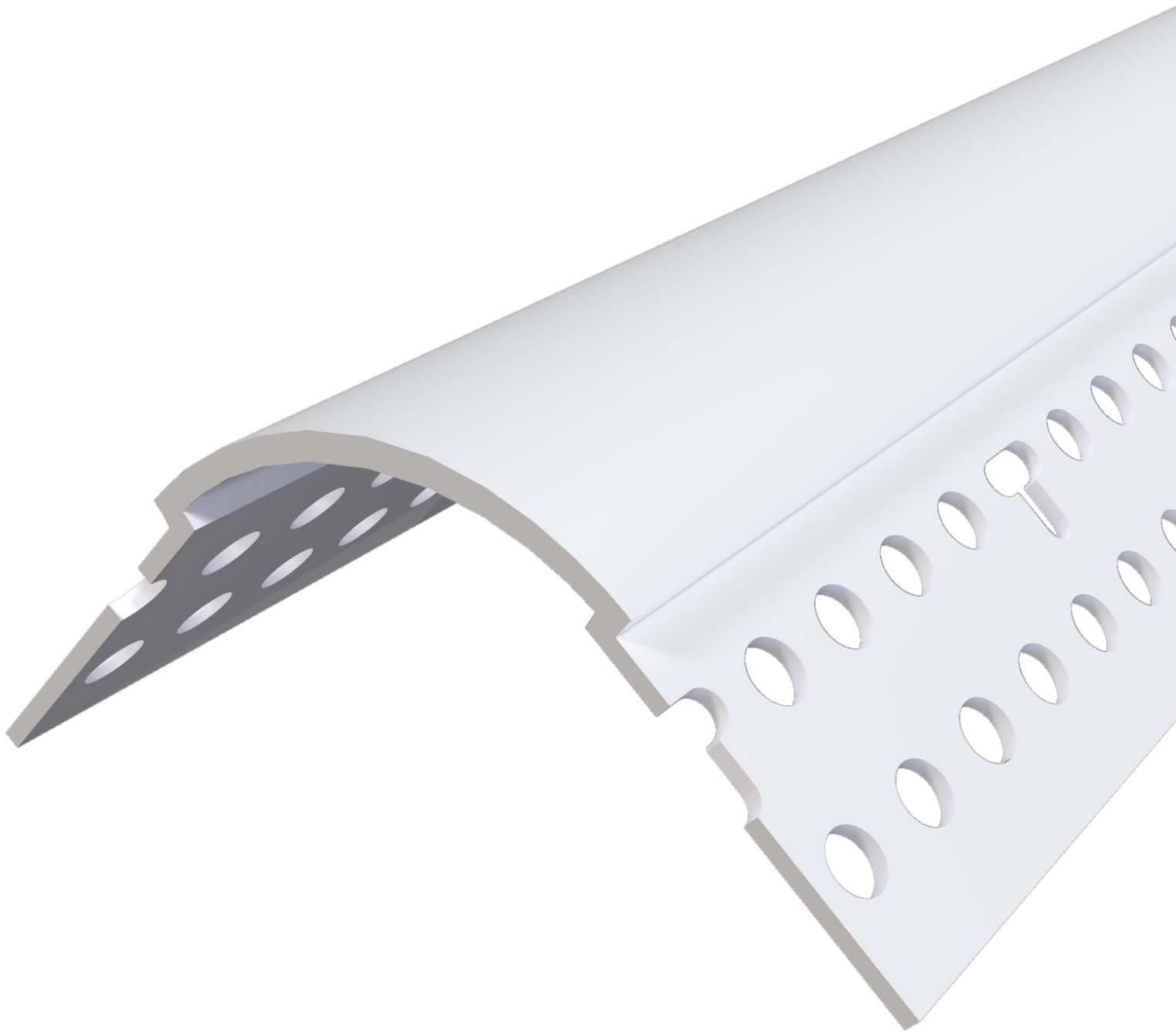

3/16" Small Bullnose Corner Bead

New!

| STOCK NO. | LENGTH | PCS. PER BOX |
|-----------|--------|--------------|
| 31610 | 10' | 50 |

Introducing the smallest-radius Bullnose bead on the market! The tightly rounded profile of 3/16" Small Bullnose Corner Bead is contemporary and subtle, yet nonetheless distinct. A drywall corner outfitted with this soft edge shows that its owner has a uniquely modern sense of style, without sacrificing functionality or durability.

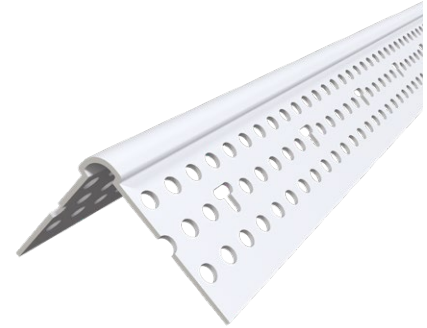

3/8" Medium Bullnose Corner Bead and Archway

****Also known as 350 Bull****

With a stylish 3/8" radius, the medium-sized Bullnose Corner Bead provides a more subtle bullnose finish to corners and archways than its larger-radius cousins. A perfect pick for those looking for an alternative to straight 90-degree corners. Like all our Bullnose profiles, its PVC construction allows it to stand up to abuse.

| STOCK NO. | LENGTH | PCS. PER BOX |
|----------------|--------|--------------|
| 35008 | 8' | 35 |
| 35009 | 9' | 35 |
| 35010 | 10' | 35 |
| ARCHWAY | | |
| 35020 | 10' | 25 |



Mud Set 3/8" Medium Bullnose Corner Bead

****Also known as 350 Bull****

Mud Set Beads are the strongest and most impact-resistant corner solutions on the market, and this style offers all that durability in the form of a 3/8" Bullnose edge. This soft, rounded corner bead provides a unique style that is a safer alternative to 90-degree corner beads, great for schools and healthcare facilities.

| STOCK NO. | LENGTH | PCS. PER BOX |
|-----------|--------|--------------|
| MS35010 | 10' | 50 |



3/8" Medium Bullnose Splayed Corner Bead

****Also known as 350 Bull****

If you need a highly protective solution for obtuse angles that's still stylish and modern, look no further – Trim-Tex's 3/8" Medium Bullnose Splayed Corner Bead is made specifically for off-angles, with a soft rounded profile that adds a contemporary flourish to any corner. This unique bead is flexible enough to accommodate most off-angle applications.

| STOCK NO. | LENGTH | PCS. PER BOX |
|-----------|--------|--------------|
| 35030 | 10' | 35 |



3/8" Medium Bullnose Kerfed Bead

Also known as 350 Bull

A kerfed bead like this one is an ideal solution to make drywall terminations into windows and doors, providing a clean contemporary look without traditional millwork. This profile is made with a medium-sized 3/8" radius, and would work well alongside the rest of our 3/8" Medium Bullnose family to complete the look throughout any room.

| STOCK NO. | LENGTH | PCS. PER BOX |
|-----------|--------|--------------|
| 35080 | 10' | 35 |



3/8" Medium Bullnose Molded Corners & Accessories

Also known as 350 Bull

A perfect finish doesn't always have to mean spending lots of time and money, and in areas where multiple 3/8" Medium Bullnose beads meet, these molded corners are the perfect accessories for a faster finish. Bullnose base adapters transition rounded beads to 90-degree corners for installing baseboards.

| STOCK NO. | 350 BULL® STYLE | PCS. PER BOX |
|-----------|---------------------|--------------|
| 920 | 2-Way Inside | 50 |
| 921 | Off-Angle 3-Way | 50 |
| 922M | Miter Marker | 10 |
| 923 | 3-Way | 50 |
| 926 | 6 1/2" Base Adapter | 50 |

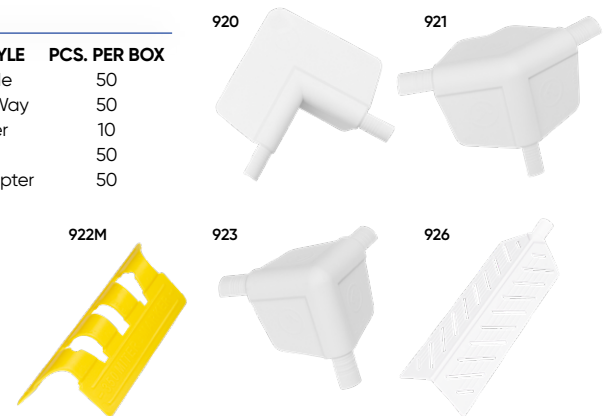

3/4" Large Bullnose Corner Bead and Archway

With its soft, rounded profile, it's no wonder that the 3/4" Large Bullnose Corner Bead & Archway remains one of Trim-Tex's most popular corner trim designs! Whether you're looking to soften your corners for a safer recreational environment or add a traditional/southwestern look to your room, Trim-Tex offers the most complete line of 3/4"-radius Bullnose products in the industry.

| STOCK NO. | LENGTH | PCS. PER BOX |
|----------------|--------|--------------|
| 7008 | 8' | 35 |
| 7009 | 9' | 35 |
| 7010 | 10' | 35 |
| 7012 | 12' | 35 |
| ARCHWAY | | |
| 7110 | 10' | 35 |



3/4" Large Bullnose Splayed Corner Bead

With a soft, rounded profile, our 3/4" Large Bullnose Splayed Corner Bead is designed to fit off-angle 135-degree outside corners. Whether you're looking to soften your corners for a safer recreational environment or add a traditional/southwestern look to your room, you can't go wrong with this popular style.

| STOCK NO. | LENGTH | PCS. PER BOX |
|-----------|--------|--------------|
| 7310 | 10' | 35 |



3/4" Large Bullnose Kerfed Bead

Doorways and windows are fantastic areas to get creative with your finish options. The leg of our 3/4" Large Bullnose Kerfed Bead can be inserted into the channel of many preformed door and window jambs to create attractive rounded encasements.

| STOCK NO. | LENGTH | PCS. PER BOX |
|-----------|--------|--------------|
| 7080 | 10' | 35 |



3/4" Large Bullnose Molded Corners & Accessories

A perfect finish doesn't always have to mean spending lots of time and money, and in areas where multiple Bullnose beads meet, these 3/4"-radius molded corners are the perfect accessories for a faster finish. Bullnose base adapters transition rounded beads to 90-degree corners for installing baseboards.

| STOCK NO. | 3/4" STYLE | PCS. PER BOX |
|-----------|-----------------------------|--------------|
| 903 | 2-Way | 50 |
| 904 | 3-Way Outside | 50 |
| 911 | 3-Way Off Angle | 50 |
| 912 | 2-Way Off Angle | 50 |
| 917 | 6 1/2" Base Adapter | 50 |
| 932M | 3/4" Miter Marker | 10 |
| 937 | 6 1/2" Splayed Base Adapter | 50 |

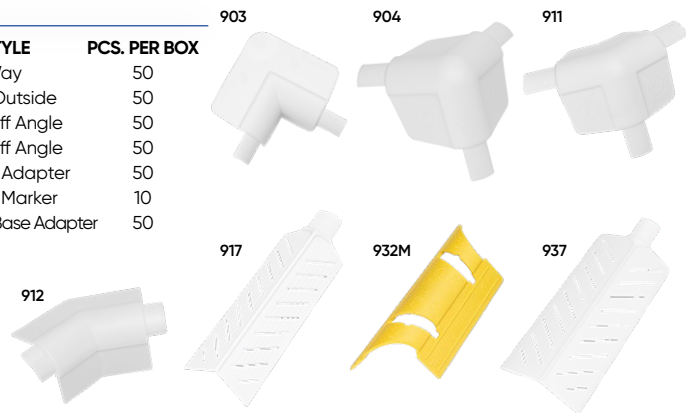

Finishing and Cleaning Tools

Due to its rounded surface, a 3/4" Large Bullnose Corner Bead provides a unique finish, but can present a challenge during the mudding process. This polypropylene Bullnose Cleaning Tool is designed to allow finishers to easily wipe down compound from this bead (including its splayed version), minimizing your time spent sanding.

| STOCK NO. | 3/4" STYLE | PCS. PER BOX |
|-----------|----------------|--------------|
| 928 | Finishing Tool | 12 |
| 929 | Cleaning Tool | 10 |



1 1/2" Jumbo Bullnose Corner Bead and Archway

Our largest bullnose profile creates sweeping rounded edges! Whether you're looking to soften your corners for a safer recreational environment or add a traditional/Southwestern look to your room, Trim-Tex's 1 1/2" Jumbo Bullnose Corner Bead & Archway is always a great choice to elevate a room beyond the ordinary.

| STOCK NO. | LENGTH | PCS. PER BOX |
|-----------|--------|--------------|
| 7099 | 10' | 30 |
| ARCHWAY | | |
| 7199 | 10' | 30 |



1 1/2" Jumbo Bullnose Molded Corners & Accessories

A perfect finish doesn't always have to mean spending lots of time and money, and in areas where multiple Bullnose beads meet, these 1 1/2"-radius molded corners are the perfect accessories for a faster finish. Bullnose base adapters transition rounded beads to 90-degree corners for installing baseboards.

| STOCK NO. | 1 1/2" STYLE | PCS. PER BOX |
|-----------|---------------------|--------------|
| 914 | 3-Way Outside | 50 |
| 915 | 3-Way Inside | 50 |
| 916 | 6 1/2" Base Adapter | 35 |

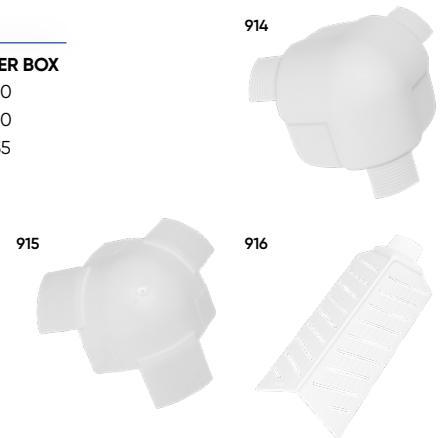

Finishing Tool

Archway Bullnose Corner Bead gives you a rounded, unique finish, but can be a challenge to coat with compound. By using this finishing tool for each coat, you will wipe the bead clean and fill the bead's notched slots with mud. Suitable for both 3/4" Large and 1 1/2" Jumbo Bullnose Archway corners.

| STOCK NO. | 1 1/2" STYLE | PCS. PER BOX |
|-----------|----------------|--------------|
| 927 | Finishing Tool | 5 |



1 1/2" Jumbo Bullnose Inside Corner Bead

Inside corners, while not always thought of as areas where one can implement interesting design choices, present a great opportunity to add subtle flair to any room. The 1 1/2" Jumbo Bullnose Inside Corner Bead brings the soft, rounded style of our popular Bullnose family of solutions to 90-degree inside corners, for a dash of added flavor.

| STOCK NO. | LENGTH | PCS. PER BOX |
|-----------|--------|--------------|
| 7066 | 10' | 30 |



Quick Tip!

Don't forget to install the drywall with proper setback for your chosen bead. See the setback guides at the beginning of each section for best results.

Q&A WITH REFRESH HOME IMPROVEMENTS

Aside from being successful rehabbers in their area, Dan and Steve Tuer of Refresh Home Improvements have become known for their funny, personable instructional videos. With hundreds of thousands of followers between their Instagram, TikTok and YouTube pages, the Toronto-based brothers take their fans behind the drywall to explain how to solve common problems.

Trim-Tex: Why do you use vinyl corner bead over other materials in your work?

Dan: We haven't been in the industry for 40 years, so we can't stand on that, but we can stand on its tests and how much easier it is for us to install it, and how much cleaner it looks when we install it.

Steve: That's the short answer, because we've done both. However many they are – I feel like we've done the paper, the metal, the vinyl. We've tried all of them, and we learned all of them. It wasn't like we were established in one method or another. They all started from a fairly equal standpoint.

Dan: Ultimately, Trim-Tex is the one we'd rather work with. What's great about our solving our drywall problems is we found a company that has solutions to all these things.

TT: In your videos, you explain how you do your work. If you do that job well, couldn't you be losing out on business?

Steve: We're magicians revealing our secrets.

TT: Yes. Why?

Steve: In my opinion, it's because I don't think that the trick has never been how it's done. It's, do you want to do it? Are you willing to do it? We always say that the skill comes with time. The skill is acquired through practice and repetition. There shouldn't be a secret in how you do this stuff. This should be accessible to everyone.

Dan: The vast majority of tradespeople come home feeling great that we've built something that we're proud of. There is so much room for happiness in the trades and we love tapping into that!!





“WE’RE
MAGICIANS
REVEALING
OUR
SECRETS.”



CHAMFER

Bring sharp lines, soft edges and stark shadows by using Chamfer corner beads on your next project, adding a hint of elegance to every edge on which they're featured.

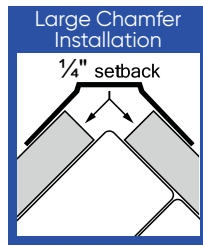

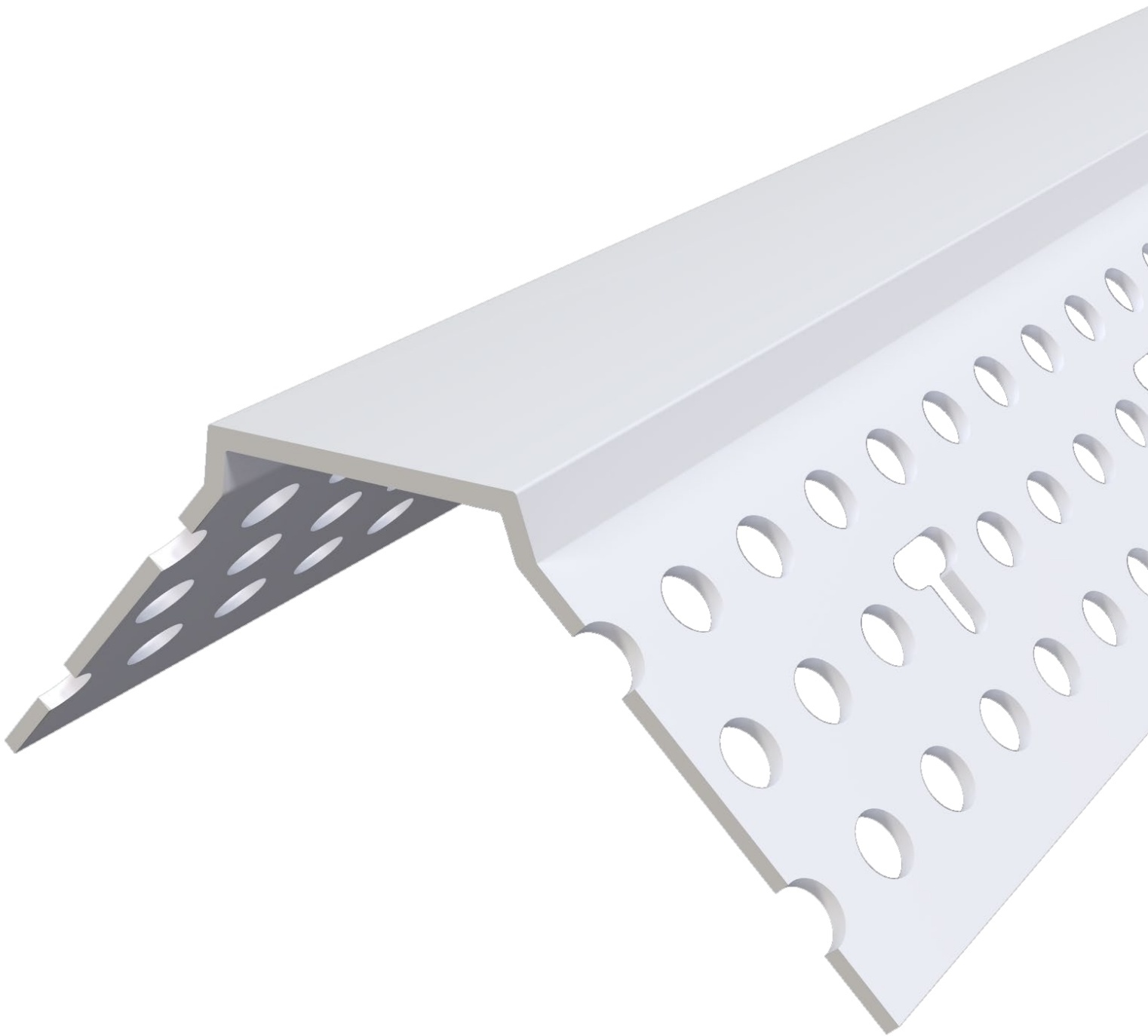

Medium Chamfer Bead[®] and Archway

Also known as 350 Chamfer

A popular style among architects, finishers and interior designers alike, Medium Chamfer Bead gives your corners a modern look with crisp lines and stark shadows. The bead's tighter, 3/4"-wide chamfered surface can soften any room, and is available in an easy-to-flex archway version to handle openings of any shape.

| STOCK NO. | LENGTH | PCS. PER BOX |
|----------------|--------|--------------|
| 9608 | 8' | 30 |
| 9609 | 9' | 30 |
| 9610 | 10' | 30 |
| ARCHWAY | | |
| 9650 | 10' | 30 |

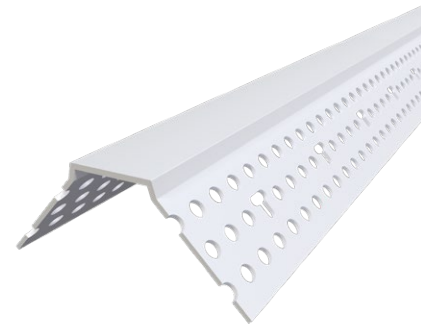

Medium Chamfer Bead[®] Splayed

Also known as 350 Chamfer

A popular style among architects, finishers and interior designers alike, Medium Chamfer Bead gives your corners a modern look with crisp lines and stark shadows. This splayed version of the bead is a stylish choice for finishing off-angles, fitting a standard 135-degree outside corner.

| STOCK NO. | LENGTH | PCS. PER BOX |
|-----------|--------|--------------|
| 9670 | 10' | 20 |

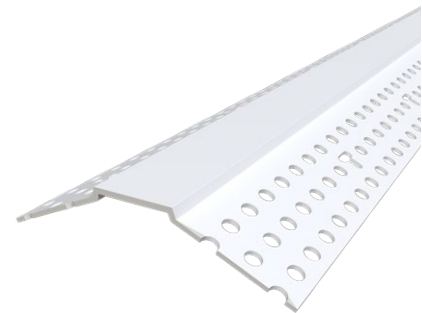

Medium Chamfer Bead[®] Molded Corners & Accessories

Also known as 350 Chamfer

A perfect finish doesn't always have to mean spending lots of time and money, and in areas where multiple Medium Chamfer beads meet, these molded corners are the perfect accessories for a faster finish. Base adapters transition Chamfer beads to 90-degree corners for installing baseboards.

| STOCK NO. | 350 CHAMFER STYLE | PCS. PER BOX |
|-----------|-----------------------------|--------------|
| 941 | 3-Way | 50 |
| 944 | 6 1/2" Base Adapter | 50 |
| 946 | 5 3/4" Splayed Base Adapter | 25 |
| 948 | Off-Angle 3-Way | 25 |

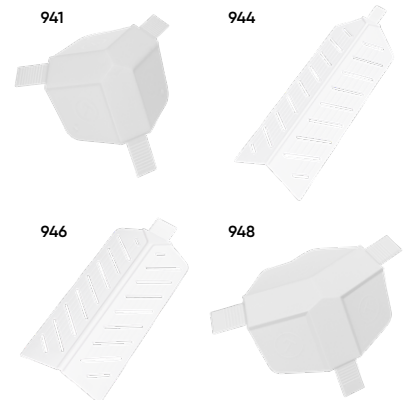

Large Chamfer Bead[®] and Archway

A popular style among architects, finishers and interior designers alike, Large Chamfer Bead gives your corners a modern look with crisp lines and stark shadows. The bead's larger, 1 1/8"-wide chamfered surface can soften any room, and is available in an easy-to-flex archway version to handle openings of any shape.

| STOCK NO. | LENGTH | PCS. PER BOX |
|----------------|--------|--------------|
| 9508 | 8' | 30 |
| 9509 | 9' | 30 |
| 9510 | 10' | 30 |
| ARCHWAY | | |
| 9550 | 10' | 30 |



Large Chamfer Bead[®] Splayed

A popular style among architects, finishers and interior designers alike, Large Chamfer Bead gives your corners a modern look with crisp lines and stark shadows. This splayed version of the bead is a stylish choice for finishing off-angles, fitting a standard 135-degree outside corner.

| STOCK NO. | LENGTH | PCS. PER BOX |
|-----------|--------|--------------|
| 9570 | 10' | 20 |



Large Chamfer Bead[®] Molded Corners & Accessories

A perfect finish doesn't always have to mean spending lots of time and money, and in areas where multiple Large Chamfer beads meet, these molded corners are the perfect accessories for a faster finish. Base adapters transition Chamfer beads to 90-degree corners for installing baseboards.

| STOCK NO. | CHAMFER STYLE | PCS. PER BOX |
|-----------|-------------------------|--------------|
| 940 | 3-Way | 50 |
| 945 | 6 3/4" Base Adapter | 50 |
| 946 | 6" Splayed Base Adapter | 25 |
| 947 | Off-Angle 3-Way | 25 |

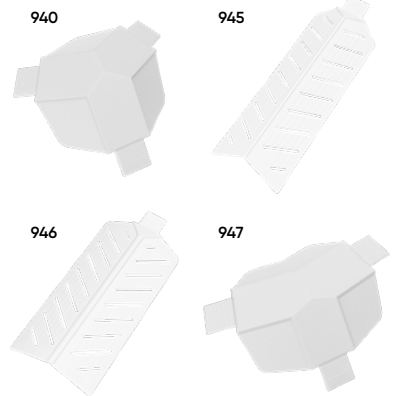

Omaha, NE

REVEAL & SHADOW BEADS

Feeling bold? Reveal & Shadow Beads raise the bar for modern trim designs, creating stylish reveal details for doors, windows, bare walls and other everyday essentials.



Architectural Reveal Bead

Reveals are a great way to add interesting design elements to a bare wall – they give any room in which they’re installed a sleek, modern and unique quality. Trim-Tex’s Architectural Reveal Bead creates the sharpest, cleanest aesthetic reveals in drywall you can get, with 1/8" of built-in expansion control.

| STOCK NO. | SIZE | LENGTH | PCS. PER BOX |
|-----------|-------------|--------|--------------|
| AS5150 | 1/4" x 1/4" | 10' | 25 |
| AS5130 | 3/8" x 3/8" | 10' | 20 |
| AS5110 | 1/2" x 1/2" | 10' | 20 |
| AS5325 | 5/8" x 5/8" | 10' | 15 |



Architectural F Reveal Bead

Architectural F Reveal Bead takes the trimless look to a whole new level, and subtly elevates everyday room details. This solution is your secret weapon for creating sharp, clean edge reveal effects when butting up to door jambs, windows and other unfinished interior architectural components.

| STOCK NO. | SIZE | LENGTH | PCS. PER BOX |
|-----------|-------------|--------|--------------|
| AS8720 | 3/8" x 3/8" | 10' | 25 |
| AS8710 | 1/2" x 1/2" | 10' | 25 |
| AS8750 | 5/8" x 5/8" | 10' | 20 |



Architectural Z Shadow Bead

Architectural Z Shadow Bead is your key to executing so many elegant drywall designs, from stylishly trimless doors to walls that appear to float above the ground. The bead creates a sharp, clean edge reveal effect when butting up to ceilings, base trim and other finished interior architectural components.

| STOCK NO. | SIZE | LENGTH | PCS. PER BOX |
|-----------|-------------|--------|--------------|
| AS5410 | 1/2" x 1/4" | 10' | 50 |
| AS5510 | 1/2" x 1/2" | 10' | 50 |
| AS5610 | 1/2" x 3/4" | 10' | 50 |
| AS5810 | 5/8" x 1/2" | 10' | 50 |
| AS6010 | 5/8" x 5/8" | 10' | 50 |
| AS5910 | 5/8" x 3/4" | 10' | 50 |



Tear Away Shadow Bead and Archway with Flexible Leg

Add a dash of flavor to any room by using the Tear Away Shadow Bead & Archway to create a reveal effect when butting up to ceilings, base trims, and other finished interior architectural components. This solution features a tear-off strip to leave a clean finished edge. The archway version creates shadow effects along curved walls or soffits.

| STOCK NO. | SIZE | LENGTH | PCS. PER BOX |
|----------------|-------------|--------|--------------|
| 5510T | 1/2" x 1/2" | 10' | 25 |
| 5520T | 3/8" x 3/8" | 10' | 25 |
| ARCHWAY | | | |
| 5550T | 3/8" x 3/8" | 10' | 25 |
| 5560T | 1/2" x 1/2" | 10' | 25 |



These tables identify the minimum inside and outside radius a Shadow or Reveal bead requires to finish cleanly. Anything less than the minimum number listed for both inside and outside corners will not work.

REVEALS

| STOCK NO. | A+B SIZE | INSIDE | OUTSIDE |
|-----------|-------------|--------|---------|
| AS5150 | 1/4" x 1/4" | 1' | 1' |
| AS5130 | 3/8" x 3/8" | 1' | 2' |
| AS5110 | 1/2" x 1/2" | 6' | 3' |
| AS5325 | 5/8" x 5/8" | 9' | 4' |

F REVEALS

| STOCK NO. | A+B SIZE | INSIDE | OUTSIDE |
|-----------|-------------|--------|---------|
| AS8710 | 1/2" x 1/2" | 7' | 6' |
| AS8720 | 3/8" x 3/8" | 5' | 4' |
| AS8750 | 5/8" x 5/8" | 9' | 7' |

Z-SHADOW

| STOCK NO. | A+B SIZE | INSIDE | OUTSIDE |
|-----------|-------------|--------|---------|
| AS5410 | 1/2" x 1/4" | 12' | 20' |
| AS5510 | 1/2" x 1/2" | 12' | 20' |
| AS5610 | 1/2" x 3/4" | 12' | 20' |
| AS5810 | 5/8" x 1/2" | 20' | 25' |
| AS6010 | 5/8" x 5/8" | 20' | 25' |
| AS5910 | 5/8" x 3/4" | 20' | 25' |



J BEADS

Cap unfinished drywall edges quickly and easily with the J Bead, the first vinyl drywall finishing bead ever manufactured, kicking off Trim-Tex as an industry powerhouse back in 1969.

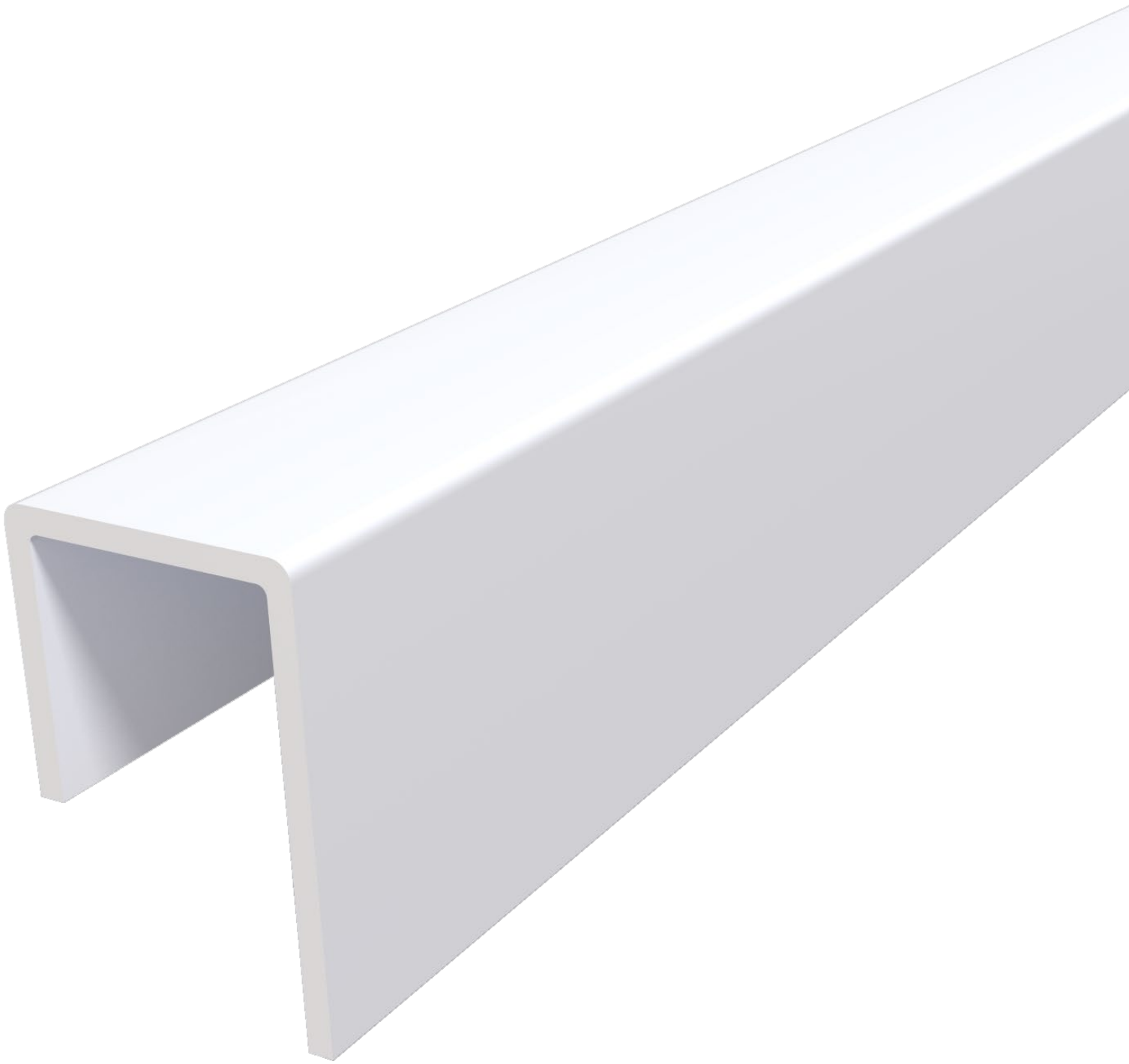

J Bead

The bead that started it all! The world's first vinyl drywall finishing bead, this venerable profile still caps unfinished drywall with unparalleled ease – no mud required! Use this bead anywhere a finished drywall edge is called for.

| STOCK NO. | SIZE | LENGTH | PCS. PER BOX |
|-----------|------|--------|--------------|
| 1010 | 3/8" | 10' | 50 |
| 1108 | 1/2" | 8' | 50 |
| 1110 | 1/2" | 10' | 50 |
| 1210 | 5/8" | 10' | 50 |

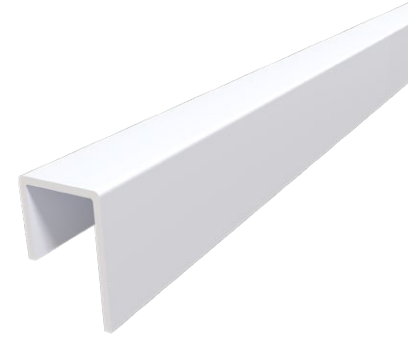

Mud On J Bead

An ideal profile to transition between drywall and another surface material such as tile, glass or wood. The bead installs with adhesive spray and staples for extra strength and finishes with mud for a seamless transition.

| STOCK NO. | SIZE | LENGTH | PCS. PER BOX |
|-----------|------|--------|--------------|
| 1710 | 1/2" | 10' | 50 |
| 1810 | 5/8" | 10' | 50 |

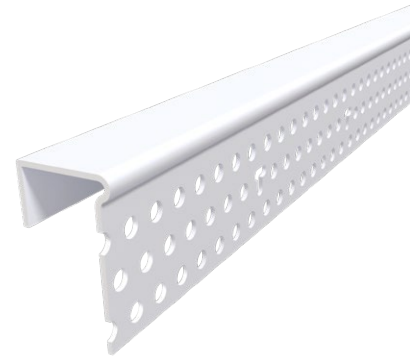

Shadow Line J Bead

Perfect solution for capping unfinished drywall quickly and easily – no mud required! This bead has a slightly raised profile on one side that imparts a contemporary finish option.

| STOCK NO. | SIZE | LENGTH | PCS. PER BOX |
|-----------|------|--------|--------------|
| 1308 | 1/2" | 8' | 50 |
| 1310 | 1/2" | 10' | 50 |
| 1410 | 5/8" | 10' | 50 |

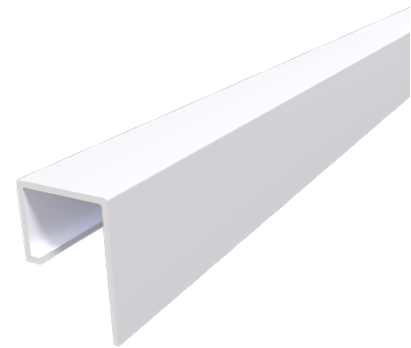

INSPIRATION FROM DRYWALLERS LIKE YOU

With the right solutions and a little imagination, there are endless possibilities for drywall design. Trim-Tex users worldwide prove that every day – check out these eye-catching creations from real drywall finishers.

Go above and beyond on your next project, and tag Trim-Tex or use **#trimtex_drywall** to possibly be featured on our social media feeds!

DRYWALL ISN'T FINISHED WITHOUT YOU!

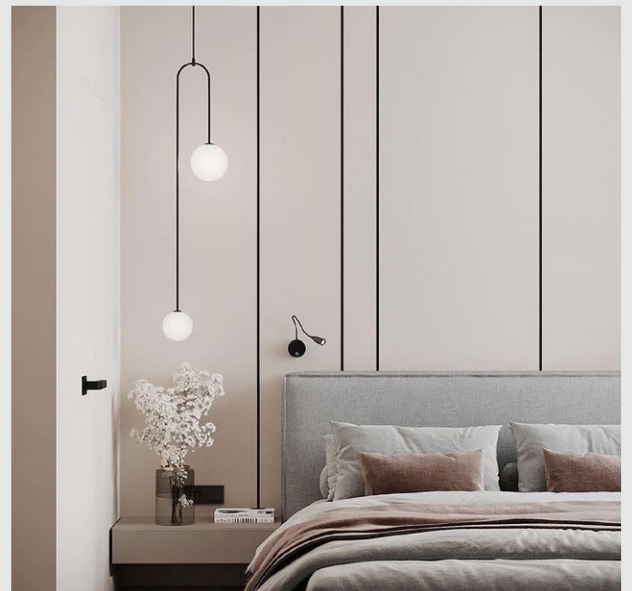
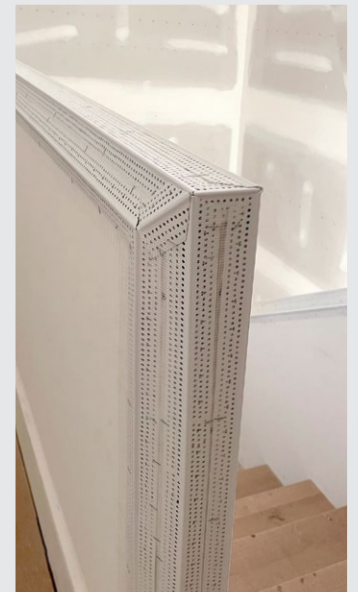

L BEADS

Whether you're working around window returns, base trims or countless other details, you can't find a cleaner or handier solution for finishing the rough edge of drywall than these L Beads.



Architectural L Bead and Archway

Finish the rough edge of drywall with the sharpest and cleanest L Bead on the market. The possibilities with Architectural L Bead are practically endless, from flawless window returns to intricate ceiling designs to flush baseboards. Its Archway variety is great around ductwork and piping, as well as for finishing columns, curved walls and soffits.

| STOCK NO. | SIZE | LENGTH | PCS. PER BOX |
|----------------|--------|--------|--------------|
| AS3206 | 3/8" | 10' | 80 |
| AS3210 | 1/2" | 10' | 80 |
| AS3310 | 5/8" | 10' | 80 |
| AS3410 | 3/4" | 10' | 50 |
| AS3510 | 1" | 10' | 50 |
| AS3610 | 1 1/4" | 10' | 50 |
| AS3650 | 1 1/2" | 10' | 50 |
| ARCHWAY | | | |
| AS3266 | 3/8" | 10' | 50 |
| AS3288 | 1/2" | 10' | 50 |
| AS3299 | 5/8" | 10' | 50 |

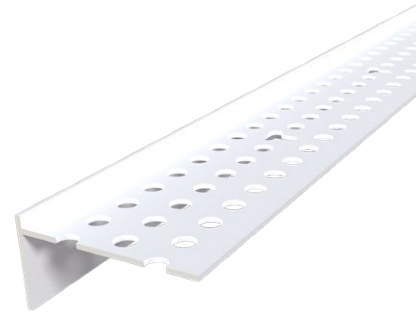

Tear Away[®] L Bead

This is the gold standard for finishing drywall around windows, doors and other essentials. Tear Away Bead features a convenient tear-off strip, which acts as a guide for your taping knife and a protective mask for mudding, resulting in smooth finished edges and far less cleanup.

| STOCK NO. | SIZE | LENGTH | PCS. PER BOX |
|-----------|------|--------|--------------|
| 9002 | 1/4" | 10' | 50 |
| 9004 | 3/8" | 10' | 50 |
| 9008 | 1/2" | 8' | 50 |
| 9010 | 1/2" | 10' | 50 |
| 9012 | 1/2" | 12' | 50 |
| 9110 | 5/8" | 10' | 50 |



Shower Bead

The must-have solution for finishing around showers and tubs! Shower Bead bridges gaps 2" or less between drywall and other substrates. But finishers especially love it for shower/tub enclosures because it uses significantly less mud than filling and paper-taping those sizable gaps, offering a mold-free alternative to paper in damp areas like these.

Use 9358 for 1/2" drywall and 9368 for 5/8" drywall

| STOCK NO. | SIZE | LENGTH | PCS. PER BOX |
|-----------|------|--------|--------------|
| 9358 | 3/8" | 8' | 25 |
| 9368 | 1/2" | 8' | 25 |



Flat Tear Away[®] L Bead

For finishing around building components like windows and doors, where the drywall is sometimes butted too close to slip a return leg behind it – or when backing materials, like acoustical sealant, have been added – Flat Tear Away can be a lifesaver. Its tear-off strip serves as a protective mask to create clean finished edges.

| STOCK NO. | SIZE | LENGTH | PCS. PER BOX |
|-----------|------|--------|--------------|
| 9000 | Flat | 10' | 50 |



Pullaway[®] L Bead

Got a messy job that needs maximum masking protection? This bead's for you! This Pullaway L Bead creates a smooth finished edge when drywall meets another substrate. Its removable strip pulls out easily after finishing, and provides up to ½" of masking protection.

| STOCK NO. | SIZE | LENGTH | PCS. PER BOX |
|-----------|------|--------|--------------|
| 3010 | ½" | 10' | 35 |



Lincolnwood, IL

WHAT IS BUTTBOARD?

Buttboard is an OSB (oriented strand board) solution used to create flat butt joints using less mud, saving users both time and money. It's not just a regular plank of wood, though; it's uniquely engineered to be slightly thicker on each side than it is in the middle.

Meanwhile, a butt joint forms anytime two cut ends of drywall sheets meet, or "butt up," against each other – meaning, without the cavity created by factory-tapered edges, your finishing work will form a hump that must be feathered out properly to get a smooth, paint-ready surface. And hiding that joint is a slow and fussy process, requiring a considerable buildup of mud.

Since Buttboard has that sunken middle section, attaching your drywall sheets to this backing material instead of just your studs means it's able to pull back the cut edges of those sheets, simulating a factory edge. This way, we still get that recessed joint in the drywall, helping you to create perfectly flat walls using around half the time and material you would otherwise.

Installation is simple:

- Center joint between the studs – do not attach the drywall to the studs on either side of the joint.
- Install Buttboard with the black dotted line (which you'll find running down the center of the plank) facing the drywall.
- Install screws every eight to 12 inches, one inch back from the drywall butt edge.
- Butt the end of the second drywall into place, leaving a slight gap, and attach to the Buttboard.
- Finally, install the screws on the adjoining studs.

See page 64 for more product info!





MADE FOR MOVEMENT

Structural movement can be a finisher's worst enemy, causing cracks and costly damage – these sophisticated solutions eliminate this threat, creating faultless finishes that stand the test of time.

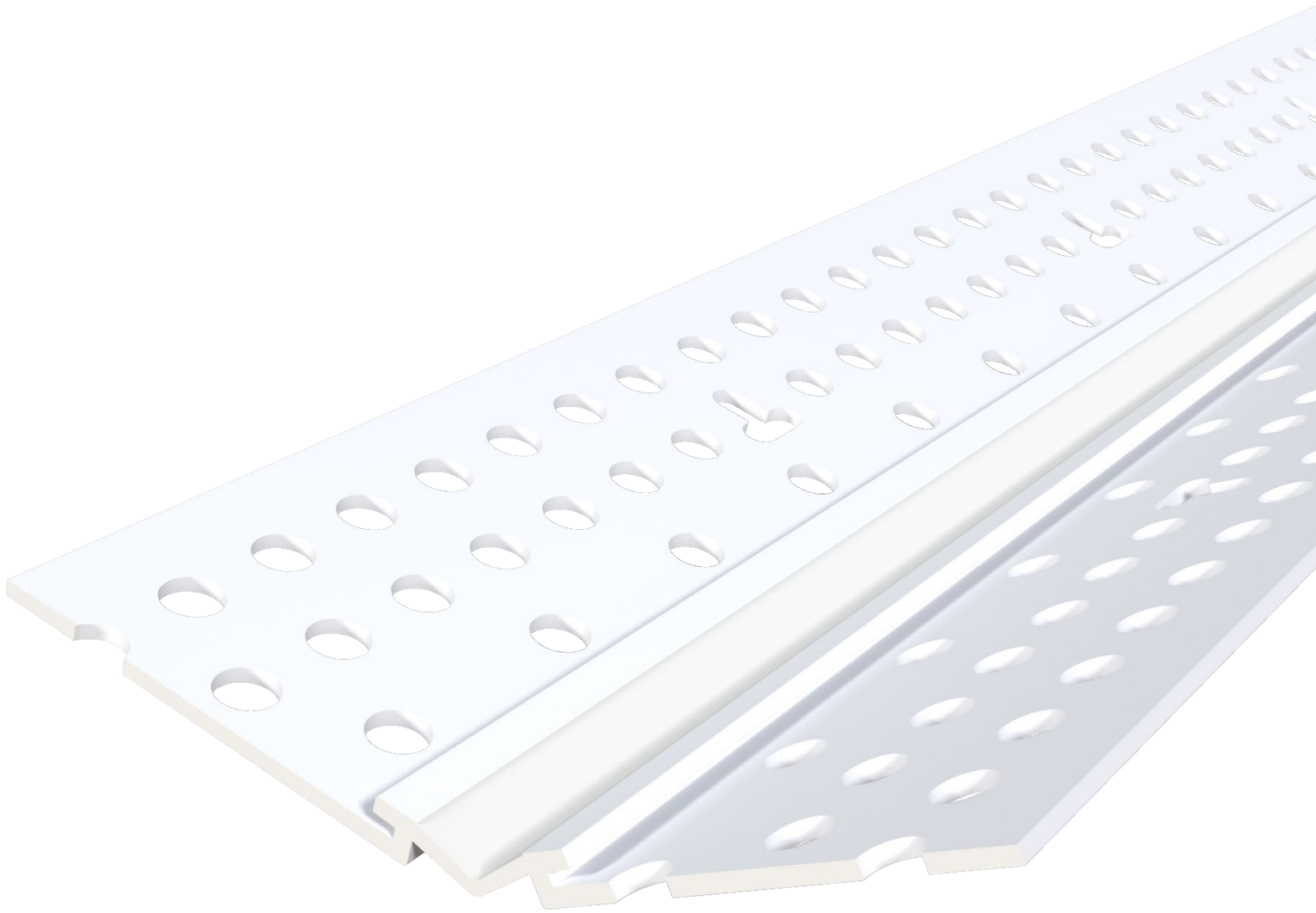

Magic Corner™

For drywallers who have a lot of inside corners to finish and not a lot of time, Trim-Tex's Magic Corner Expansion Bead lives up to its name. Like magic, it installs quickly and easily, even on off-angles and vaulted ceilings. Magic Corner counteracts inside-corner cracking from structural movement, allowing up to 3/8" in controlled movement.

| STOCK NO. | LENGTH | PCS. PER BOX |
|-----------|--------|--------------|
| 4366 | 10' | 50 |
| 4320 | 200' | 1 Roll |



093V Expansion

Control joints have met their match! This bead is meticulously crafted of both rigid and flexible PVC to create a deep "V" that flexes to accommodate 3/8" in building movement. Tear off strips make finishing easy.

| STOCK NO. | LENGTH | PCS. PER BOX |
|-----------|--------|--------------|
| 093V | 10' | 20 |



Hideaway Expansion

This expansion bead features a shallow profile while still accommodating up to 3/8" in building movement thanks to its rigid and flexible PVC construction. Finish is a breeze with its tear off strips. The finished result produces a very stealthy control joint.

| STOCK NO. | LENGTH | PCS. PER BOX |
|-----------|--------|--------------|
| 2710 | 10' | 25 |



Deflection Bead

When a wall joint is subject to the stresses of building movement, the Wall Mounted Deflection Bead is the best solution for the job. Its flexible gasket is able to form a perfect seal within the joint, compressing and expanding during deflection (up to 7/16"), thus preventing inside corner cracking.

| STOCK NO. | LENGTH | PCS. PER BOX |
|-----------|--------|--------------|
| 9220 | 10' | 48 |



Flat Deflection Bead

This simple solution prevents inside corner cracking when installed against a ceiling or concrete deck that may be subject to movement, to be used alongside backing materials in the head-of-wall gap for a code-compliant assembly. Its flexible gasket compresses and expands, providing protection for up to ½" of deflection, while its tear-off strip leaves a clean finished edge.

| STOCK NO. | LENGTH | PCS. PER BOX |
|-----------|--------|--------------|
| 9230 | 10' | 60 |



Super Seal Tear Away[®] L Bead

Super Seal Tear Away possesses a flexible bubble gasket, which forms a perfect, permanent seal around windows, doors and areas where drywall butts up to concrete walls. This reduces sound transmission, replacing acoustical caulk, and provides relief from the stresses of structural movement. The attached tear-off strip acts as a protective mask for mudding.

| STOCK NO. | SIZE | LENGTH | PCS. PER BOX |
|-----------|------|--------|--------------|
| 9210 | ¾" | 10' | 25 |



Truss Backing Angle

Truss uplift can cause inside corner cracking on interior partition walls that can be costly and time-consuming to repair. Attaching your framing to Truss Backing Angle eliminates this risk entirely, allowing trusses to expand and contract independently while the drywall along your inside corners stays firmly in place.

| STOCK NO. | LENGTH | PCS. PER BOX |
|-----------|--------|--------------|
| 8050 | 10' | 25 |



CODE COMPLIANCE

Combining the craftsmanship of Trim-Tex's tried-and-true vinyl beads with cutting-edge firestopping and soundproofing technology, these speedy code compliance solutions blaze past unreliable sealants and sprays to chart a new path forward.

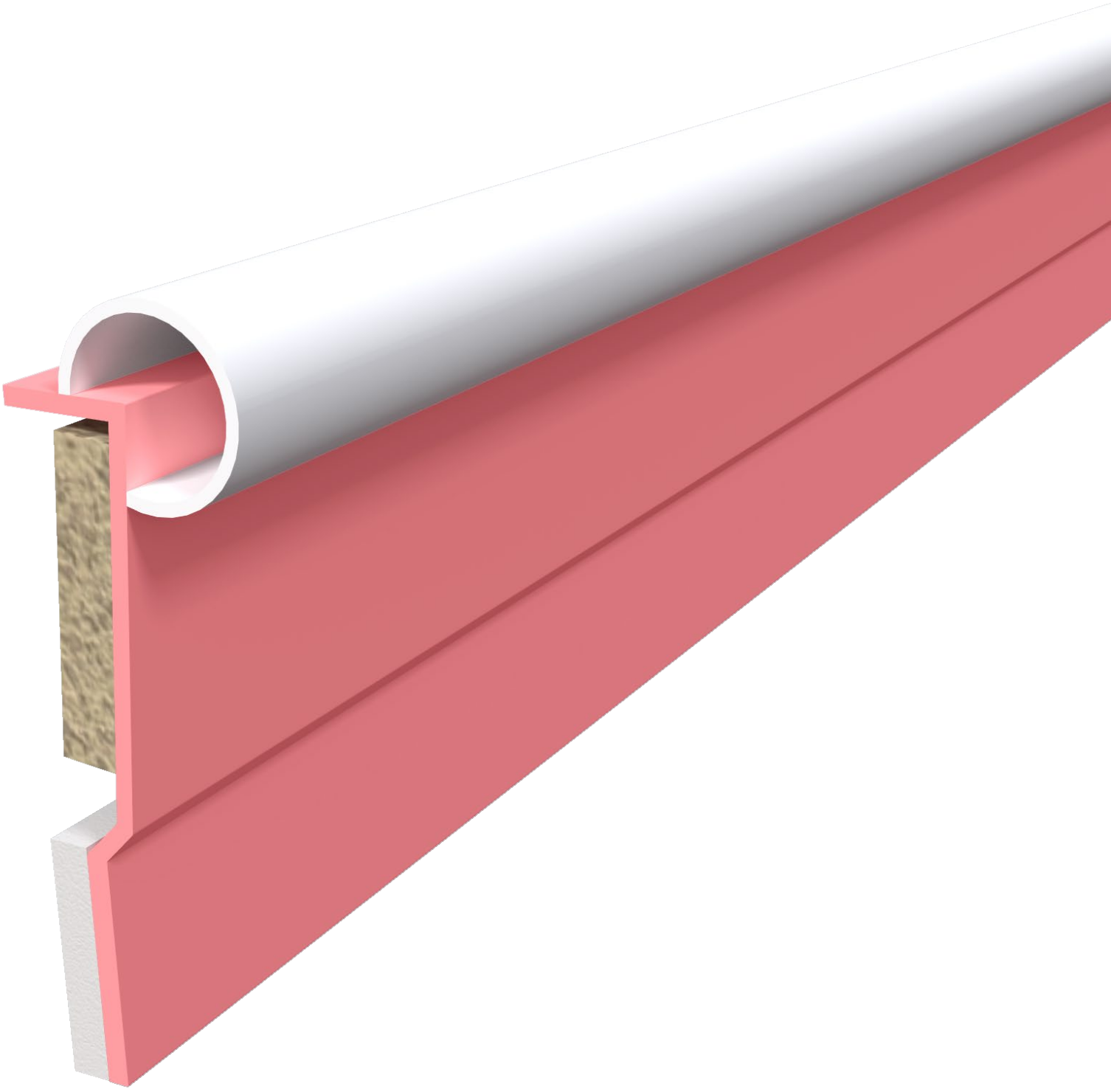

Fire Rated 093V Expansion

Building out fire-rated control joints on wall assemblies using traditional methods is costly and time consuming. Our fire rated 093X-V expansion bead revolutionizes this process. Integrated intumescent tape is fire rated up to 2 hours, and the flexible bead accommodates up to $\frac{3}{8}$ " in building movement.

| STOCK NO. | LENGTH | PCS. PER BOX |
|-----------|--------|--------------|
| 093X-V | 10' | 20 |



Fire Bead™

Fast, simple and cost-effective, Fire Bead is the new go-to standard for firestopping in wall joints. Available in 1- and 2-hour fire ratings, Fire Bead provides protection for up to $\frac{1}{2}$ " of building deflection with cutting-edge firestopping technology to halt the passage of smoke, fire and sound.

| STOCK NO. | LENGTH | PCS. PER BOX |
|------------|--------|--------------|
| 9250 - 1hr | 10' | 30 |
| 9260 - 2hr | 10' | 22 |

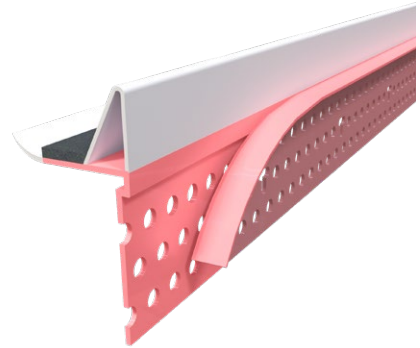

Hotrod XL™

Hotrod XL is a powerful and versatile fire rated drywall accessory, built to slam the brakes on the passage of smoke, fire and sound. This solution combines Trim-Tex's Flat Deflection Bead with compressible foam and intumescent tape for a perfect seal along head-of-wall joints, providing a full $\frac{3}{4}$ " of building movement.

| STOCK NO. | LENGTH | PCS. PER BOX |
|-----------|--------|--------------|
| 9280 | 10' | 10 |

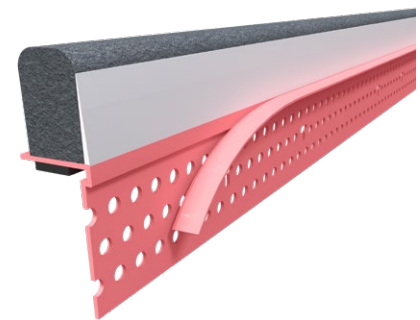

Hotrod Type-X[®]

Combining compressible foam with intumescent tape that expands when exposed to intense heat, Hotrod Type-X replaces finicky fire sprays over mineral wool. Its rectangular profile is easily compressed into a deflection gap between drywall and its adjoining structure for a fast, simple firestopping solution. Pair with Flat Deflection Bead (page 45) for seamless results.

| STOCK NO. | SIZE | LENGTH | PCS. PER BOX |
|-----------|----------------------|--------|--------------|
| 9284 | $\frac{1}{2}$ " x 1" | 4' | 20 |
| 9285 | 1" x 1" | 4' | 10 |

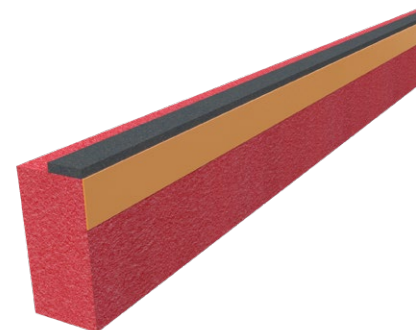

Fire Gasket™

Fire Gasket is the fastest firestopping solution for head-of-wall joints on the market, installing up to five times faster than traditional sealants and sprays. Fire Gasket is installed pre-drywall, and is available in three different sizes to provide a range of unencumbered movement – 0.5", 1" and 1.5".

| STOCK NO. | SIZE | LENGTH | PCS. PER BOX |
|-----------|------|--------|--------------|
| 9265 | ½" | 10' | 20 |
| 9270 | 1" | 10' | 20 |
| 9275 | 1½" | 10' | 20 |

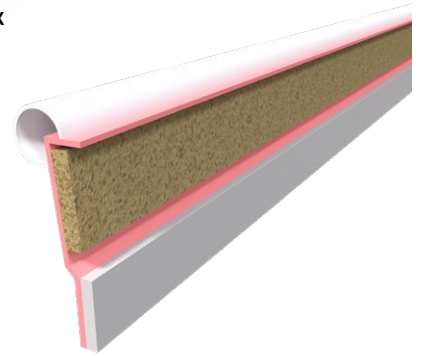

Sound Gasket™

Preventing the passage of noise through head-of-wall joints has never been easier or faster than installing Trim-Tex's Sound Gasket. This simple drywall accessory – a vinyl profile, bubble gasket (providing up to 1" of building movement) and adhesive foam – is the most advanced soundproofing solution for wall joints on the market.

| STOCK NO. | LENGTH | PCS. PER BOX |
|-----------|--------|--------------|
| 9290 | 10' | 20 |



Smoke & Sound Stop

Smoke & Sound Stop is a compressible, rectangular length of foam, providing a flexible backing for smoke and sound abatement within interior building joints. Made from fabricated open-cell polyurethane, Smoke & Sound Stop is a simple, easily installed sound-dampening solution. Not recommended for wet areas.

| STOCK NO. | LENGTH | PCS. PER BOX |
|-----------|--------|--------------|
| 9286 | 1080' | 1 Roll |

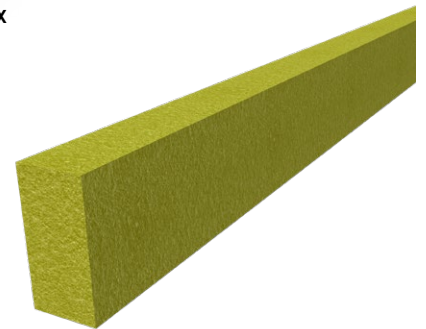



**“DEFINITELY,
I’M SAVING
MONEY!”**

SOUND GASKET CASE STUDY: CHULA VISTA, CA

How Trim-Tex's Sound Gasket Revolutionized Soundproofing
for This SoCal Luxury Apartment Complex

In Chula Vista, Calif., multifamily housing is being built almost as fast as you can find people to fill them. For builders, this kind of sky-high demand for luxury living spaces presents some serious challenges, especially when it comes to code compliance requirements, like dampening the passage of sound between units. Traditional methods of soundproofing for wall joints (i.e., acoustical caulks) are tricky to install, often requiring multiple trips by the finishing crews to get the job done correctly.



Tired of the labor/material costs and callbacks acoustical caulk so frequently requires, the team at Southern California Interiors, Inc., started to search for a better, faster way. And soon enough, they discovered Sound Gasket, the most advanced soundproofing solution for wall joints on the market. By using Sound Gasket on all bottom-of-wall joints between units at The Avalyn – a luxury apartment complex project comprised of eight buildings and 480 individual units – they were able to take care of their soundproofing work up to five times faster than before; eliminate installer errors causing callbacks; and, instead of going into each unit two to five times to apply and re-apply caulk, each apartment only required one trip by one installer to get it right.

“Going back, refilling, doing it twice, three times – realistically, we don’t have the money for that,” said Southern California Interiors President/CEO

Jesse Rodriguez. “We get paid to caulk on the bottom regardless of the conditions, whether we do it once good, or whether we do it five times on our own dime ... Then, we compare it to [Sound Gasket] and say, okay, what the cost of your product is, based upon all the other things we have to buy to make sealants work – believe it or not, I’m saving money that way. Definitely, I’m saving money!”

“In my eyes, it’s a superior product to the caulking all around,” added Southern California Interiors Estimator/Project Manager Anthony Anderson. “In regards to ‘training’ our guys, if you will, there hasn’t been a big learning curve. The guys have a unit down and, after that, they’re pretty much on the ground running on all the other units as well. It’s just overall better product. It’s cleaner, it’s faster and our guys are picking it up pretty quick.”

ACOUSTICAL & CEILING BEADS

Elevate your ability to work with ceiling tiles, getting the job done faster and easier than ever, while allowing you to shape your ceilings alongside curved wall surfaces.

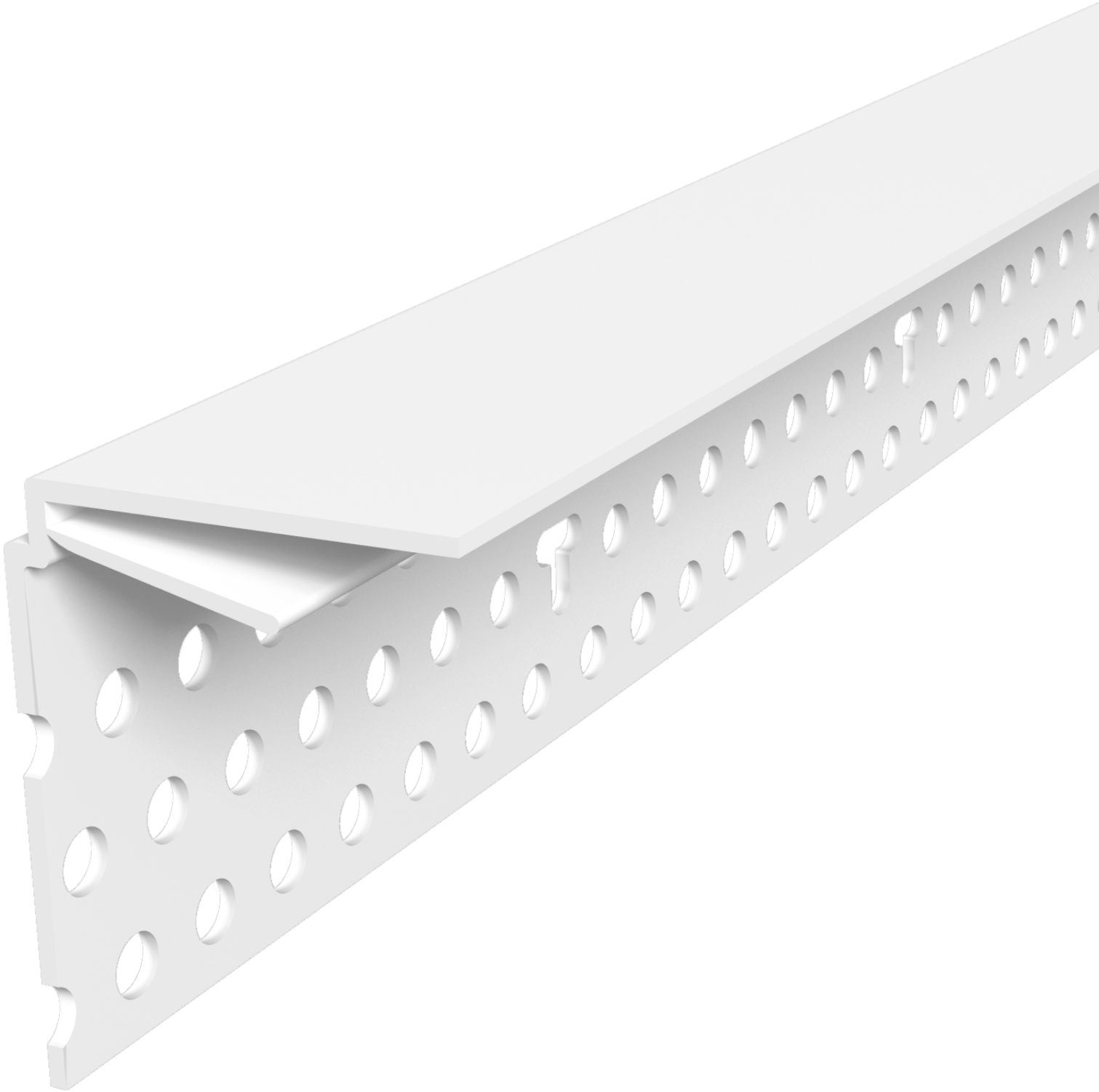



Flex Grid Angle

Acoustical tiles may be standard for commercial ceilings, but they can be limiting for designs that go beyond straight, squared walls. This is why we introduced Flex-Grid Angle, the ultimate way to easily finish acoustical ceilings terminating at curved walls or surfaces, with multiple radiuses to fit most contours.

| STOCK NO. | SIZE | LENGTH | PCS. PER BOX |
|-----------|-------|--------|--------------|
| 8158 | 7/8" | 8' | 63 |
| 8159 | 9/16" | 8' | 63 |



Mud On Ceiling Bead

The Mud On Ceiling Bead makes working with drywall and drop ceilings faster and easier than ever. Use this solution wherever a new wall butts up against an existing drop ceiling, with ceiling tiles resting on its vinyl flange. The tear-off protective masking protects the visible flange from joint compound and paint for easy clean-up.

| STOCK NO. | SIZE | LENGTH | PCS. PER BOX |
|-----------|-------|--------|--------------|
| 5010 | 7/8" | 10' | 40 |
| 5012 | 7/8" | 12' | 40 |
| 5020 | 9/16" | 10' | 40 |

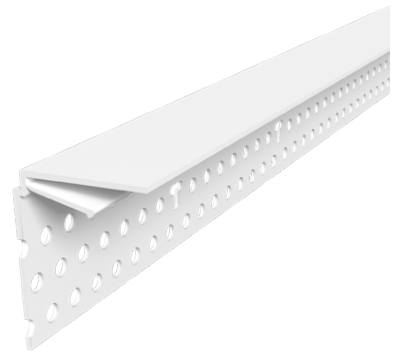

RETURNS & JAMBS

Finishing window returns, door jambs and rough drywall openings has never been easier thanks to these solutions. Rack up big time and material savings with these big beads!

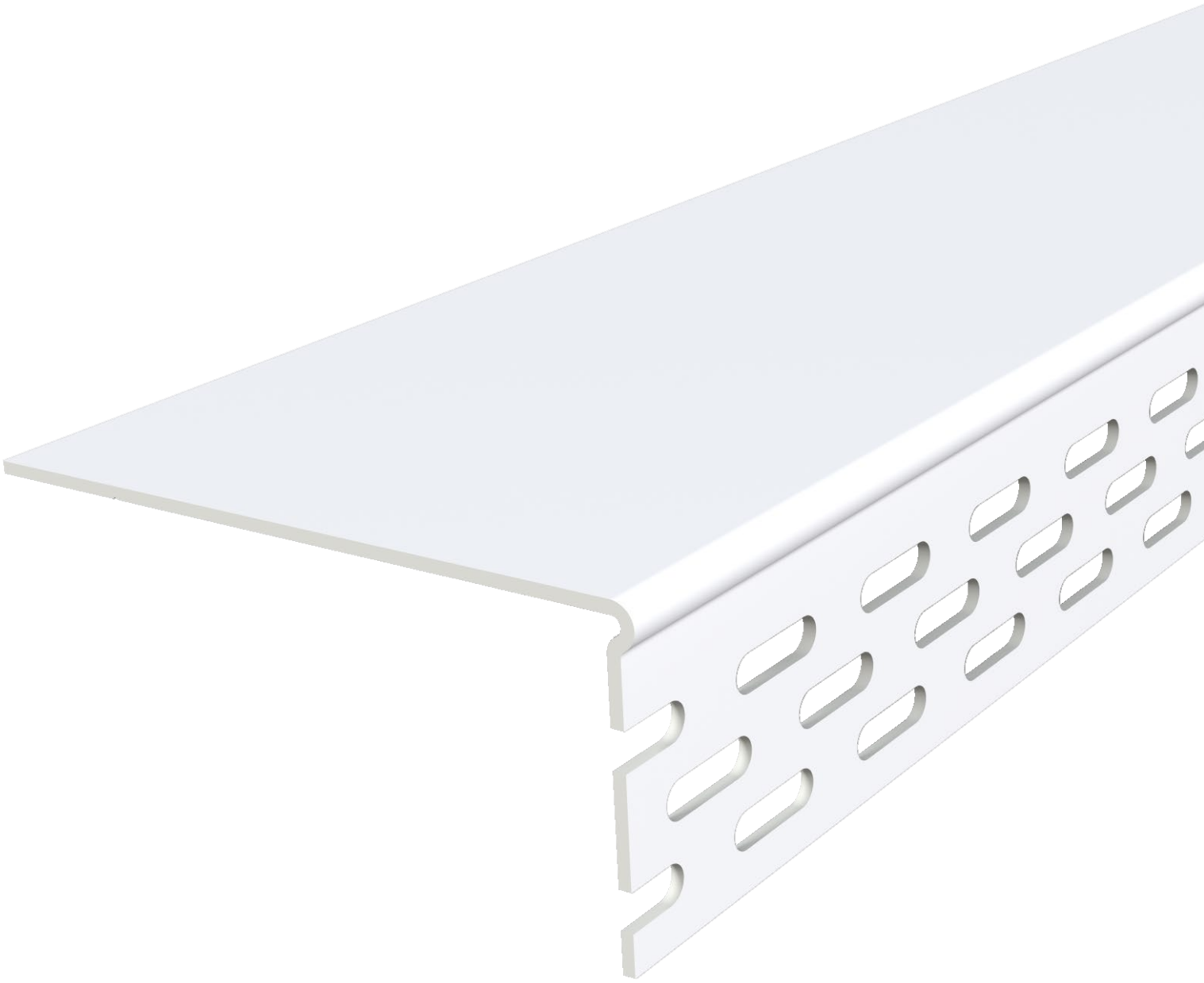

Fast Cap

For drywall pros searching for new ways to speed up their finishing jobs, we have the solution you're looking for: Fast Cap. Use this on doorways, wall ends, knee walls and closets to totally eliminate the need for finishing drywall faces and corner beads. 4 5/8" Fast Cap is designed for 2 x 4 wood studs only; the 4 7/8" Fast Cap can be used with wood studs or 3 5/8" metal studs. Fast Cap 3 1/2" and 3 3/4" are designed to be used with 2 1/2" metal studs.

| STOCK NO. | SIZE | LENGTH | PCS. PER BOX |
|-----------|--------|--------|--------------|
| 4410 | 4 5/8" | 10' | 10 |
| 4510 | 4 7/8" | 10' | 10 |
| 4883 | 3 1/2" | 10' | 10 |
| 4810 | 3 3/4" | 10' | 10 |

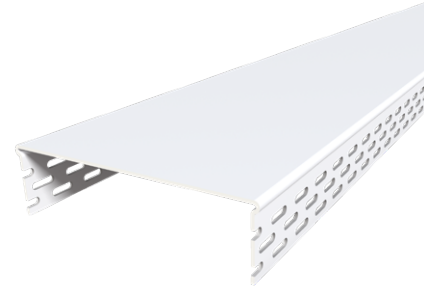

Oversized L Bead

Finishing window returns can often require extra layers of drywall, lots of joint compound and a combination of corner beads. Or you can use just one solution – an Oversized L Bead. Designed to save labor and material, it features a pre-scored tear-off strip, making the bead fit two sizes in one (2 1/16" & 2 1/8").

| STOCK NO. | SIZE | LENGTH | PCS. PER BOX |
|-----------|------------------|--------|--------------|
| 3611 | 2 1/16" & 2 1/8" | 10' | 30 |

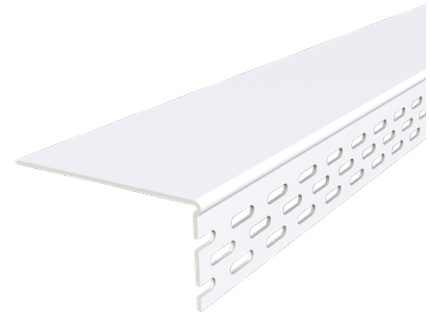

Super L Bead and Archway

To save material and labor on larger surfaces of exposed drywall, like deep window returns, you can't beat the ease and efficiency of Super L Bead & Archway. This solution boasts a super-wide 3 1/8" return leg, and is pre-scored at 2 5/8", 2 1/8" and 1 5/8", making the bead fit four sizes in one. The archway version is great for finishing arched window returns.

| STOCK NO. | LENGTH | PCS. PER BOX |
|----------------|--------|--------------|
| 3710 | 10' | 30 |
| ARCHWAY | | |
| 3810 | 10' | 30 |



Giant L Bead and Archway

The largest vinyl L Bead you can get! Save material and labor on larger surfaces of exposed drywall, like deep window returns, with Giant L Bead & Archway. This solution boasts a giant 5 5/8" return leg and is pre-scored at 4 13/16", 4 5/16" and 3 13/16", making the bead fit four sizes in one. The archway version is great for finishing arched window returns.

| STOCK NO. | LENGTH | PCS. PER BOX |
|----------------|--------|--------------|
| 3850 | 10' | 20 |
| ARCHWAY | | |
| 3860 | 10' | 20 |





TOOLS & ACCESSORIES

From abrasives to drywall backers to access doors to installation aids, Trim-Tex has you covered, helping you execute a flawless finish on every job, every time.



847[®] Spray Adhesive

A must-have for pro drywall finishers, 847 Spray Adhesive is the key to flawlessly installing most Trim-Tex vinyl beads. A high-tack, pressure-sensitive spray, 847 is carefully formulated to provide extremely strong adhesion between vinyl beads and drywall.

| STOCK NO. | PCS. PER BOX |
|-----------|------------------|
| 847 | 1 case = 12 cans |



Powdered Mud-Max[®]

If you want to easily improve the strength and adhesive performance of all drywall joint compounds, textures and plaster products, Powdered Mud-Max is your go-to solution. A single 2.5 gallon bucket of Powdered Mud-Max is good for up to 80 standard-size buckets of joint compound.

| STOCK NO. | PCS. PER BOX |
|-----------|--------------|
| 855 | 14lb bucket |



Black Widow[®] Pro Sander

The Black Widow Pro Sander covers more surface area with less user fatigue, and no hard edges means no scuffing on inside corners. Its pole extends to 48", and its quick-change system makes this the go-to sanding tool of choice for drywall pros.

| STOCK NO. | DESCRIPTION | PCS. PER BOX |
|-----------|---------------|--------------|
| 540 | Sander | 4 |
| 540P | Sander & Pole | 4 |



Black Widow[®] Sanding Pads

Black Widow Sanding Pads are the abrasives of choice for drywall pros. Each pad's abrasive grit is bonded directly to the foam, so there's no hard edges to scuff inside corners.

| STOCK NO. | GRIT | PCS. PER BOX |
|-----------|--------------|-------------------|
| 560-FX | Extra Fine | 24 (4 packs of 6) |
| 560-F | Fine | 24 (4 packs of 6) |
| 560-M | Medium | 24 (4 packs of 6) |
| 560-C | Coarse | 24 (4 packs of 6) |
| 560-CX | Extra Coarse | 24 (4 packs of 6) |

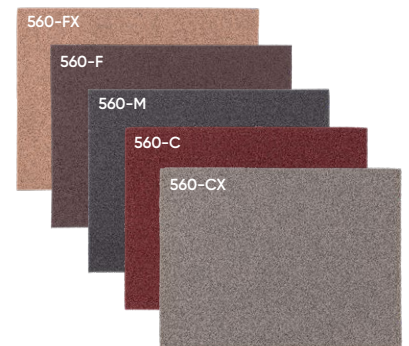

Full Circle Sanding Tools

The Radius 360° Sanding Tool's unique round shape, die-cast aluminum head and wide pivot brackets speeds up the sanding process, allowing finishers to quickly maneuver in any direction without lifting the sanding pad. This tool is perfect for sanding large surface areas, with a variety of accessories to match any job.

| STOCK NO. | STYLE | PCS. PER BOX |
|-----------|-----------------------|--------------|
| 360 | 360 Sanding Tool | 6 |
| 360-PWRPD | 9" Power Pad | 6 |
| 362 | Std. Foam Repl. Pad | 6 |
| 365-80 | Sanding Disc 80 Grit | 100 |
| 365-100 | Sanding Disc 100 Grit | 100 |
| 365-120 | Sanding Disc 120 Grit | 100 |
| 365-150 | Sanding Disc 150 Grit | 100 |
| 365-180 | Sanding Disc 180 Grit | 100 |
| 365-220 | Sanding Disc 220 Grit | 100 |
| 365-240 | Sanding Disc 240 Grit | 100 |
| 365-280 | Sanding Disc 280 Grit | 100 |



Dual Angle Dual Grit Sanding Block

Pro drywallers handpick Trim-Tex's abrasives for a flawless finish. Our Dual Angle Sanding Block – which is 40% larger than standard blocks, measuring 5" x 3¼" – features two tapered edges to simplify corner sanding and two radius edges to prevent gouging and scuffing.

| STOCK NO. | GRIT | PCS. PER BOX |
|-----------|-------------|--------------|
| 885F | Fine/Fine | 24 |
| 885F-BULK | Fine/Fine | 100 |
| 885 | Medium/Fine | 24 |
| 885-BULK | Medium/Fine | 100 |



Single Angle Sanding Block

Pro drywallers handpick Trim-Tex's abrasives for a flawless finish. Our Single Angle Sanding Block is 40% larger than standard blocks, and features a steep tapered edge, designed to prevent unintentional sanding of the opposite wall. The opposite edge benefits from Trim-Tex's exclusive radius corner, which prevents scratching and gouging.

| STOCK NO. | GRIT | PCS. PER BOX |
|-----------|--------|--------------|
| 888F | Fine | 24 |
| 888F-BULK | Fine | 100 |
| 888M | Medium | 24 |
| 888M-BULK | Medium | 100 |



Buttboard™ Drywall Backer

Trim-Tex's solution to eliminating butt-joint bulges is a favorite among pro drywall finishers. Buttboard Drywall Backer is a uniquely engineered OSB plank that pulls back the edges of the cut end of the drywall, creating a tapered edge that requires far less time and far less joint compound to finish.

| STOCK NO. | LENGTH | PCS. PER BOX |
|-----------|--------|--------------|
| 825 | 48" | 12 |
| 826 | 54" | 12 |
| 825S | 48" | 500 |
| 826S | 54" | 500 |



Jacksonville, FL

Pro Series 4-in-1 Hopper

For Fast Edge[®], Mud Set Beads and more, you can't find a better companion tool for a quick and painless installation than the Pro Series 4-in-1 Hopper. Includes inserts to fit a variety of profiles. Simply fill the hopper with joint compound, slide the bead through and apply it directly to the drywall – that's all there is to it!

| STOCK NO. | DESCRIPTION | PCS. PER BOX |
|-----------|-------------|--------------|
| 390 | Hopper | 1 |
| 391 | Stand | 1 |



Pro Series Quad Roller

Consider the Pro Series Quad Roller your magic wand for executing perfectly straight corner beads every time. Its four self-aligning wheels evenly apply pressure to the bead, with custom-built heads for flawlessly installing Fast Edge[®] or mud set corners. Includes a 54" aluminum pole.

| STOCK NO. | DESCRIPTION | PCS. PER BOX |
|-----------|------------------------------|--------------|
| 460 | 90° Mud Set | 1 |
| 463 | Fast Edge [®] Paper | 1 |



Pop-Out Flat Access Door

For quick access to plumbing parts, wiring or any other locations where access is required at regular intervals, a solid Flat Access Door Panel like this one is going to be crucial. Featuring a convenient pop-out door, this panel is designed to blend in with your drywall, and is created from glass fiber reinforced gypsum for increased strength. Available in rounded or squared corner styles.

Custom sizes available. Call for quote.

| STOCK NO. | SIZE | STYLE |
|-----------|-----------|---------------|
| RC-12 | 12" x 12" | Radius Corner |
| RC-16 | 16" x 16" | Radius Corner |
| RC-18 | 18" x 18" | Radius Corner |
| RC-24 | 24" x 24" | Radius Corner |
| SQ-12 | 12" x 12" | Square Corner |
| SQ-16 | 16" x 16" | Square Corner |
| SQ-18 | 18" x 18" | Square Corner |
| SQ-24 | 24" x 24" | Square Corner |



Hinged Flat Access Door

For quick access to plumbing parts, wiring or any other locations where access is required at regular intervals, a solid Flat Access Door Panel like this one is going to be crucial. Featuring a convenient hinged door, this panel is designed to blend in with your drywall, and is created from glass fiber reinforced gypsum for increased strength. Available in rounded or squared corner styles.

Custom sizes available. Call for quote.

| STOCK NO. | SIZE | STYLE |
|-----------|-----------|-----------------------|
| RCHG-12 | 12" x 12" | Slotted Radius Corner |
| RCHG-24 | 24" x 24" | Slotted Radius Corner |
| SQHG-12 | 12" x 12" | Slotted Square Corner |
| SQHG-24 | 24" x 24" | Slotted Square Corner |



093V Expansion

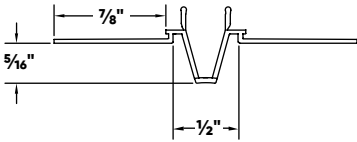

Adjustable Inside Corner Bead

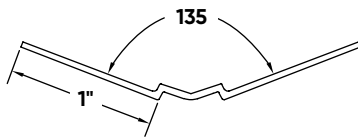

Architectural F Reveal Bead

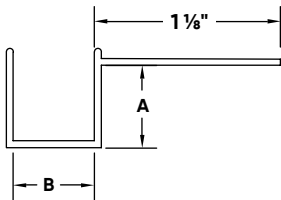

| STOCK NO. | A+B SIZE |
|-----------|-------------|
| AS8710 | 1/2" x 1/2" |
| AS8720 | 3/8" x 3/8" |
| AS8750 | 5/8" x 5/8" |

Architectural L Bead & Archway

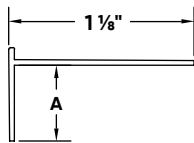

| STOCK NO. | A SIZE |
|-----------|--------|
| AS3206 | 3/8" |
| AS3210 | 1/2" |
| AS3310 | 5/8" |
| AS3410 | 3/4" |
| AS3510 | 1" |
| AS3610 | 1 1/4" |
| AS3650 | 1 1/2" |

| ARCHWAY | A SIZE |
|---------|--------|
| AS3266 | 3/8" |
| AS3288 | 1/2" |
| AS3299 | 5/8" |

Architectural Reveal Bead

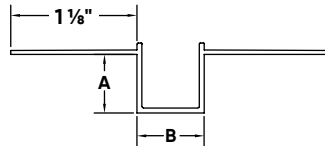

| STOCK NO. | A+B SIZE |
|-----------|-------------|
| AS5150 | 1/4" x 1/4" |
| AS5130 | 3/8" x 3/8" |
| AS5110 | 1/2" x 1/2" |
| AS5325 | 5/8" x 5/8" |

Architectural Z Shadow Bead

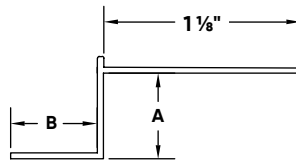

| STOCK NO. | A+B SIZE |
|-----------|-------------|
| AS5410 | 1/2" x 1/4" |
| AS5510 | 1/2" x 1/2" |
| AS5610 | 1/2" x 3/4" |
| AS5810 | 5/8" x 1/2" |
| AS6010 | 5/8" x 5/8" |
| AS5910 | 5/8" x 3/4" |

Bullnose Corner Bead, 3/16" Small

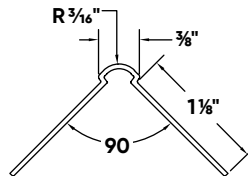

Bullnose Corner Bead & Archway, 3/8" Medium

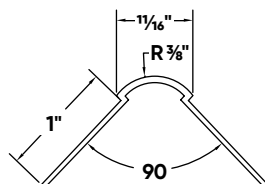

Bullnose Corner Bead & Archway, 3/4" Large

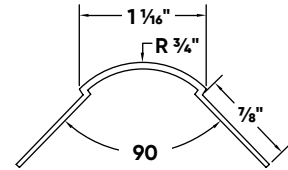

Bullnose Corner Bead & Archway, 1 1/2" Jumbo

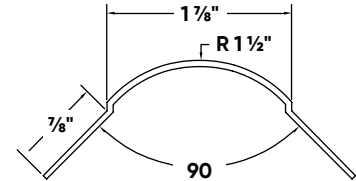

Bullnose Inside Corner Bead, 1 1/2" Jumbo

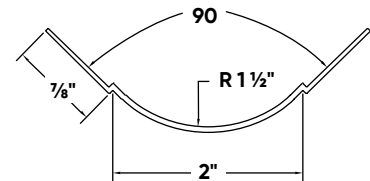

Bullnose Kerfed Bead, 3/8" Medium

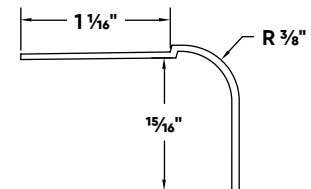

Bullnose Kerfed Bead, 3/4" Large

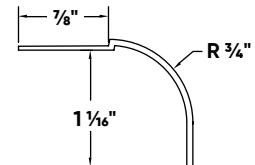

Bullnose Splayed Corner Bead, 3/8" Medium

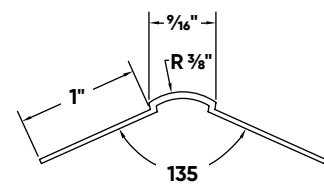

Bullnose Splayed Corner Bead, 3/4" Large

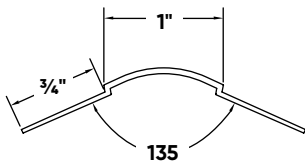

Chamfer Bead® & Archway, Medium

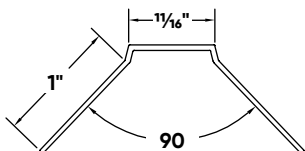

Chamfer Bead® & Archway, Large

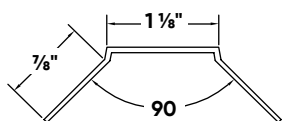

Chamfer Bead® Splayed, Medium

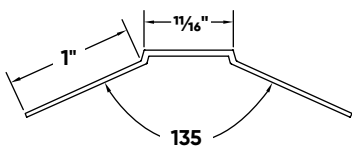

Chamfer Bead® Splayed, Large

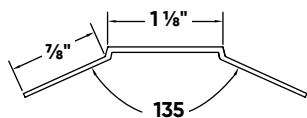

Corner Bead & Archway

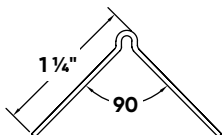

Deflection Bead

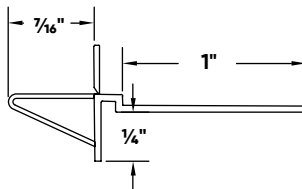

Fast Cap

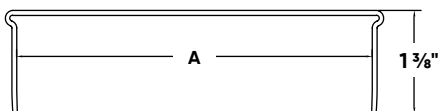

| STOCK NO. | A SIZE |
|-----------|--------|
| 4410 | 4 5/8" |
| 4510 | 4 7/8" |
| 4883 | 3 1/2" |
| 4810 | 3 3/4" |

Fast Edge®

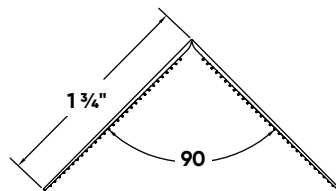

Fast Edge® Paper

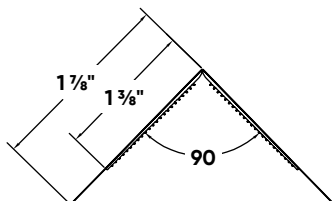

Fast Edge® Rolls

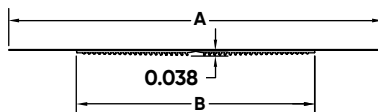

| STOCK NO. | A SIZE | B SIZE |
|-----------|--------|--------|
| FE275R | 2 3/4" | 1 3/4" |
| FE325R | 3 1/4" | 2 1/4" |
| FE375R | 3 3/4" | 2 3/4" |
| FE450R | 4 1/2" | 3 5/8" |

Fire Bead

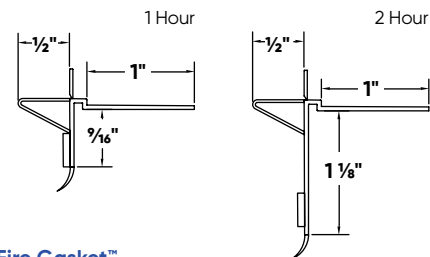

Fire Gasket™

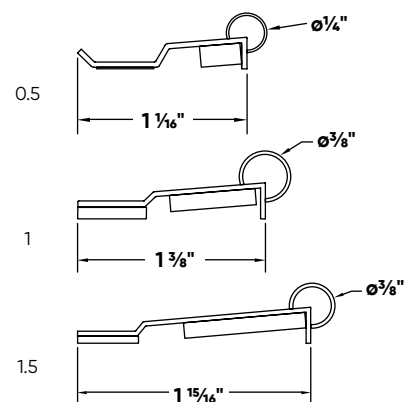

Fire Rated 093V Expansion

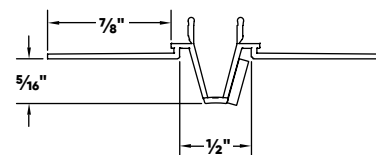

Flat Deflection Bead

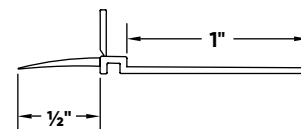

Flat Tear Away® L Bead

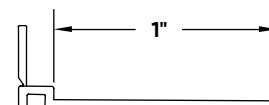

Flex Grid Angle

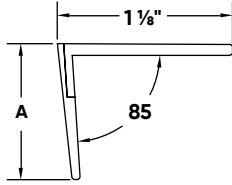

| STOCK NO. | A SIZE |
|-----------|--------|
| 8158 | 7/8" |
| 8159 | 9/16" |

Giant L Bead & Archway

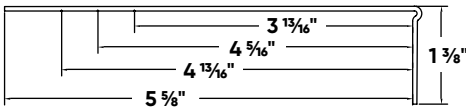

Hideaway Expansion

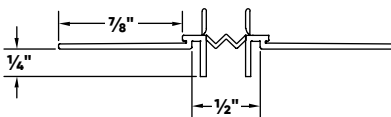

Hotrod Type X®

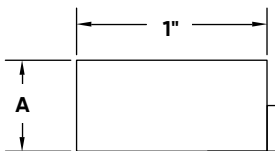

| STOCK NO. | A SIZE |
|-----------|--------|
| 9284 | 1/2" |
| 9285 | 1" |

Hotrod XL™

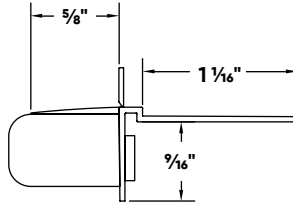

J Bead

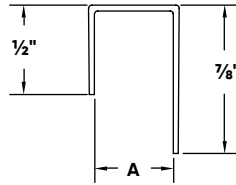

| STOCK NO. | A SIZE |
|-----------|--------|
| 1010 | 3/8" |
| 1108 | 1/2" |
| 1110 | 1/2" |
| 1210 | 5/8" |

Jumbo Corner Bead & Archway

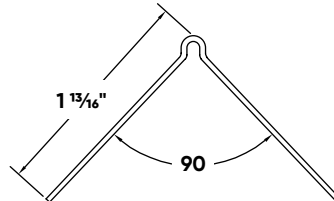

Jumbo Splayed Corner

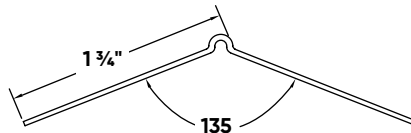

Magic Corner™

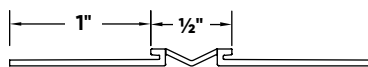

Mud On Ceiling Bead

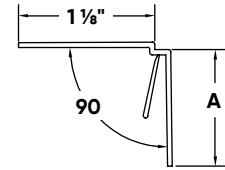

| STOCK NO. | A SIZE |
|-----------|--------|
| 5010 | 7/8" |
| 5012 | 7/8" |
| 5020 | 9/16" |

Mud On J Bead

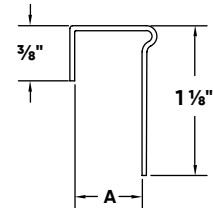

| STOCK NO. | A SIZE |
|-----------|--------|
| 1710 | 1/2" |
| 1810 | 5/8" |

Outside Splayed Corner Bead

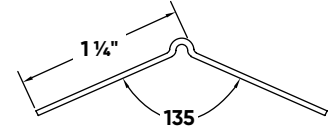

Oversized L Beads

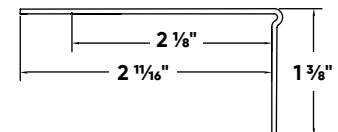

Pullaway® L Bead

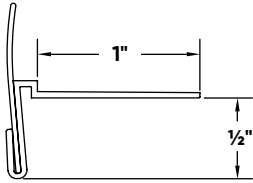

Rigid Jumbo Low Profile Corner Bead & Archway

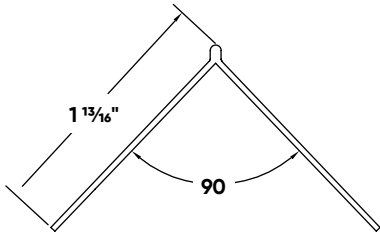

Rigid Low Profile Corner Bead & Archway

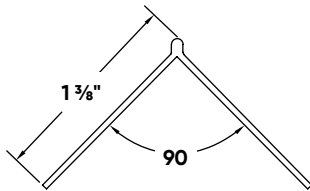

Closed Angle

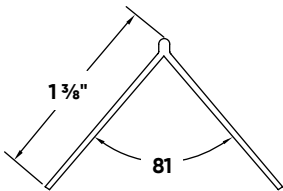

Rigid Splayed Adjustable Corner Bead

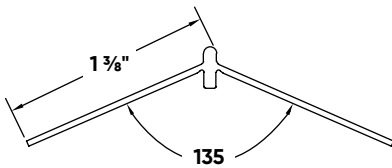

Shadow Line J Bead

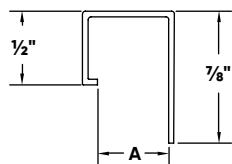

| STOCK NO. | A SIZE |
|-----------|--------|
| 1308 | 1/2" |
| 1310 | 1/2" |
| 1410 | 5/8" |

Shower Bead

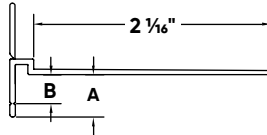

| STOCK NO. | A SIZE | B SIZE |
|-----------|--------|--------|
| 9358 | 3/8" | 1/4" |
| 9368 | 1/2" | 3/8" |

Smoke & Sound Stop

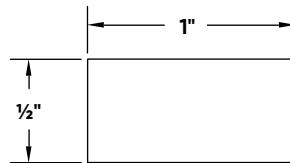

Sound Gasket™

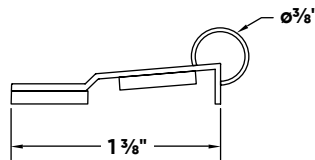

Super L Bead & Archway

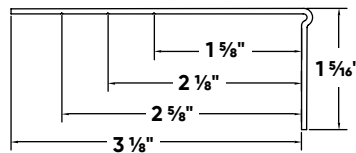

Super Seal Tear Away® L Bead

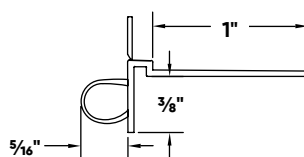

Tear Away® L Bead

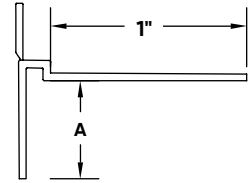

| STOCK NO. | A SIZE |
|-----------|--------|
| 9002 | 1/4" |
| 9004 | 3/8" |
| 9008 | 1/2" |
| 9010 | 1/2" |
| 9012 | 1/2" |
| 9110 | 5/8" |

Tear Away Shadow Bead & Archway w/ Flexible Leg

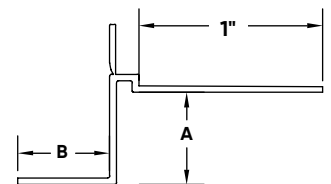

| STOCK NO. | A+B SIZE |
|-----------|-------------|
| 5510T | 1/2" x 1/2" |
| 5520T | 3/8" x 3/8" |
| ARCHWAY | |
| 5550T | 3/8" x 3/8" |
| 5560T | 1/2" x 1/2" |

Truss Backing Angle

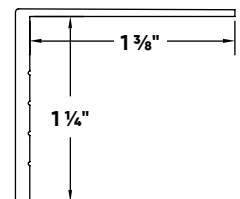

NUMERICAL

| | |
|---------------------------------------|----|
| 093V Expansion | 44 |
| 847 [®] Spray Adhesive | 62 |

A

| | |
|--|----|
| Adjustable Inside Corner Bead | 13 |
| Architectural F Reveal Bead | 30 |
| Architectural L Bead and Archway | 38 |
| Architectural Reveal Bead | 30 |
| Architectural Z Shadow Bead | 30 |

B

| | |
|---|----|
| Black Widow [®] Pro Sander | 62 |
| Black Widow [®] Sanding Pads | 62 |
| Bullnose Corner Bead, 3/16" Small | 18 |
| Bullnose Corner Bead and Archway, 3/8" Medium | 18 |
| Bullnose Corner Bead and Archway, 3/4" Large | 19 |
| Bullnose Corner Bead and Archway, 1 1/2" Jumbo | 20 |
| Bullnose Finishing and Cleaning Tools, 3/4" Large | 20 |
| Bullnose Finishing Tool, 1 1/2" Jumbo | 21 |
| Bullnose Inside Corner Bead, 1 1/2" Jumbo | 21 |
| Bullnose Kerfed Bead, 3/8" Medium | 19 |
| Bullnose Kerfed Bead, 3/4" Large | 20 |
| Bullnose Molded Corners & Accessories, 3/8" Medium | 19 |
| Bullnose Molded Corners & Accessories, 3/4" Large | 20 |
| Bullnose Molded Corners & Accessories, 1 1/2" Jumbo | 21 |
| Bullnose Splayed Corner Bead, 3/8" Medium | 18 |
| Bullnose Splayed Corner Bead, 3/4" Large | 19 |
| Buttboard [™] Drywall Backer | 64 |

C

| | |
|--|----|
| Chamfer Bead [®] and Archway, Medium | 26 |
| Chamfer Bead [®] and Archway, Large | 26 |
| Chamfer Bead [®] Molded Corners & Accessories, Medium | 26 |
| Chamfer Bead [®] Molded Corners & Accessories, Large | 27 |
| Chamfer Bead [®] Splayed, Medium | 26 |
| Chamfer Bead [®] Splayed, Large | 27 |
| Corner Bead and Archway | 08 |

D

| | |
|--|----|
| Deflection Bead | 44 |
| Dual Angle Dual Grit Sanding Block | 63 |

F

| | |
|--|----|
| Fast Cap | 58 |
| Fast Edge [®] | 13 |
| Fast Edge [®] Paper | 13 |
| Fast Edge [®] Rolls | 14 |
| Fire Bead | 48 |
| Fire Gasket [™] | 49 |
| Fire Rated 093V Expansion | 48 |
| Flat Deflection Bead | 45 |
| Flat Tear Away [®] L Bead | 38 |
| Flex Grid Angle | 55 |
| Full Circle Sanding Tools | 63 |

G

| | |
|--------------------------------|----|
| Giant L Bead and Archway | 58 |
|--------------------------------|----|

H

| | |
|----------------------------------|----|
| Hideaway Expansion | 44 |
| Hinged Flat Access Door | 65 |
| Hotrod Type X [®] | 48 |
| Hotrod XL [™] | 48 |

J

| | |
|-------------------------------------|----|
| J Bead | 34 |
| Jumbo Corner Bead and Archway | 08 |
| Jumbo Splayed Corner | 08 |

M

| | |
|---|----|
| Magic Corner [™] | 44 |
| Mud On Ceiling Bead | 55 |
| Mud On J Bead | 34 |
| Mud Set 3/8" Medium Bullnose Corner Bead | 18 |
| Mud Set Rigid Jumbo Low Profile Corner Bead | 12 |
| Mud Set Rigid Low Profile Corner Bead and Archway | 12 |

O

| | |
|-----------------------------------|----|
| Outside Splayed Corner Bead | 08 |
| Oversized L Bead | 58 |

P

| | |
|-------------------------------------|----|
| Pop-Out Flat Access Door | 65 |
| Powdered Mud Max [®] | 62 |
| Pro Series 4-in-1 Hopper | 65 |
| Pro Series Quad Roller | 65 |
| Pullaway [®] L Bead | 39 |

R

| | |
|---|----|
| Rigid Jumbo Low Profile Corner Bead and Archway | 12 |
| Rigid Low Profile Corner Bead and Archway | 12 |
| Rigid Splayed Adjustable Corner Bead | 13 |

S

| | |
|--|----|
| Shadow Line J Bead | 34 |
| Shower Bead | 38 |
| Single Angle Sanding Block | 63 |
| Smoke and Sound Stop | 49 |
| Sound Gasket [™] | 49 |
| Super L Bead and Archway | 58 |
| Super Seal Tear Away [®] L Bead | 45 |

T

| | |
|---|----|
| Tear Away [®] L Bead | 38 |
| Tear Away Shadow Bead and Archway with Flexible Leg | 30 |
| Truss Backing Angle | 45 |

Trademarks

Trim-Tex, Drywall Art, Pullaway, Tear Away, Mud Set Beads, Step a Bull, Chamfer Bead, Chamfer Stop, Chamfer 3 Way, Chamfer Marker, 350 Chamfer Bead, 350 Chamfer Arch, Magic Corner, Hideaway, 093V, Fast Cap, Mud on, Flex Grid Angle, 350 Bull, 350 Bull Arch, Miter Marker, Mud Max, Black Widow, Arch Plus, 847 are trademarks of Trim-Tex, Inc. 093X-V, Fire Bead, Fire Gasket, Sound Gasket, Hotrod Type X and Hotrod XL are trademarks of CEMCO.

Custom Lengths & Extrusions

Trim-Tex offers custom size lengths of existing product on a per-order basis, contact our customer service team for details. Custom shapes and extrusions are available upon request for orders of 10,000 linear feet or more. Tooling and die costs are separate, contact our customer service team for details and personalized quote.

Warranty

Trim-Tex, Inc. warrants that the products manufactured by Trim-Tex to be free from manufacturing defects when installed in accordance with the guidelines and instructions, where indicated, and in accordance to the customary and ordinary standards of the industry. Trim-Tex, Inc's sole responsibility shall be for the replacement of product only when it has been determined by Trim-Tex, Inc. that the product was defective as a result of manufacturing and not as a result of improper installation or handling. Trim-Tex assumed no liability or responsibility for any direct, indirect or consequential damages that may arise from the use of any product manufactured by Trim-Tex. Trim-Tex assumes no responsibility for any defective product not manufactured by Trim-Tex in which a product of Trim-Tex is attached to or made a part of said product. Neither Trim-Tex, its officers, agents or employees have the authority to make any other warranty either orally or in writing.



**Drywall isn't
finished
without us.**



3700 W Pratt Ave
Lincolnwood, IL 60712

(800) 874-2333
info@trim-tex.com
trim-tex.com